

## VERSAFLOPPY II

### Enhanced Flexible Disk Drive Controller

The Versafloppy II is a low cost versatile state-of-the-art controller board for flexible double or single density disk drives that is compatible with the S-100 Bus computer configurations.

#### General Description

Versafloppy II is a flexible disk drive controller that incorporates a wide range of capabilities into one board. It operates with double density soft-sectored format which provides 985,600 bytes of storage on a double sided 8 inch diskette and 129,920 bytes per side on a 5 inch mini-diskette. A unique feature of the Versafloppy II is that it may be used with mini or full sized floppy drives, single or double density, and single or double side, or in any combination. The Versafloppy II directly controls many popular disk drives. These include: Shugart SA400 and SA450; Shugart SA800 and SA850; Mayflower MFE500 and MFE700; Per Sci 70 and Z77; and Siemens's GSI-105.

The heart of the Versafloppy II controller board is the powerful Western Digital FD1797B-2 NMOS LSI double density controller chip. This device performs most of the timing and control functions required by floppy disk drives such as: head load and unload; track seeking and verification; address mark detection/generation; serial to parallel data conversion for reads; parallel to serial data conversion for writes; CRC error code checking and generation; IBM 3740 Soft Sector compatible recording and signaling for double density recording and precompensation.

The insertion of wait states until the FD1797B-1 is ready for the next word provides synchronization of the data rate with the CPU during sector reading and writing. Optional use of interrupts is available by using V12 and V13 as inputs to an interrupt controller on another board. These controls are not necessary for operation, but are provided for systems requiring priority interrupt signals.

#### Application Data

Versafloppy II operates with other S-100 boards to give a complete disk based system. VDB-8024, SBC-200 and the Expando-RAM II from SD SYSTEMS combine with the Versafloppy II to offer a complete data processing system.

The Versafloppy II's control function is evenly distributed between hardware and software to provide flexibility for the user. Software listings are provided with the Versafloppy II for use with the SBC-200/100 single board computer from SD SYSTEMS. This software may be modified to meet the user's specific software interface requirements, such as register usage, parameter handoffs and data formats. Also available from SD SYSTEMS is the SDOOS Operating Systems configured to run with several combinations of SD SYSTEMS boards, terminals and disk drives. This will allow the use of any of several disk based versions of high level language.

SD SYSTEMS recommends the use of DDBIOS (order #39034) to complete all necessary read/write routines for Versafloppy II when it is combined with SBC-100/200. DDBIOS also includes VFDIAC to provide diagnostic functions for the Versafloppy II when it is employed in conjunction with the SBC-100/200. VFDIAC simulates actual disk usage and reports error conditions. The Versafloppy II employs the SD Monitor to control its input/output console functions.

#### Features

- S-100 Bus Compatible
- IBM-3740 Compatible, Soft Sectored Format for Single Density Drives
- Operates with both Standard (8") and Mini (5") Drives Simultaneously
- Provides Control for Double Sided Operation
- Operates with Z80, 8080 and 8085 Central Processing Unit
- Controls up to four drives
- Vectored Interrupt Operation Optional
- Control and Diagnostic Software Available in PROM
- SDOOS Disk Operating System Compatible

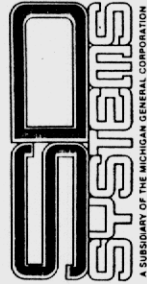
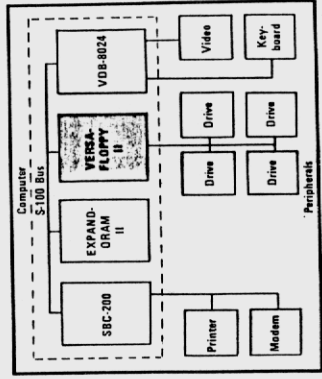

Versafloppy II operates with or without interrupts. However, the standard control software does not use interrupts.

Output Port 63 is an eight bit control register with several functions. Bits 0 through 3 are Drive Select 1, 2, 3, and 4.

Bit 4 selects the side for use with double sided drives. Bit 5 is a control for mini/full drive. Double or single density is controlled through Bit 6, and Bit 7 controls the Wait State Enable.

Input Port 63 reads the present state of Output Port 63. Bits 0—7.

## Specifications

Functional	Value
Bus	S-100
Compatible CPU's	Z80
Storage Capacity	985,600 bytes (Double-Sided) (8" diskette) 129,920 bytes per side (5" diskette)
Physical	
Dimensions (Board Size)	5.0" x 10.10" x 0.65"
Connectors	J1-S-100 Bus; J2-34 Pin; J3-50 Pin
Power Requirements	+8 VDC @ 300mA (max) +16 VDC @ 50mA (max)
Operating Temperature	0 Degrees to 50 Degrees Celsius

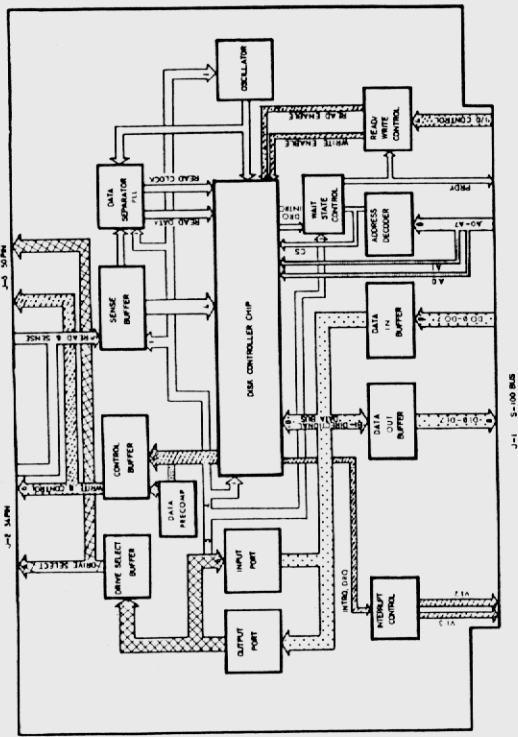

## Functional Description

The major functions contained in the Versafloppy II hardware are shown in the block diagram above. The Versafloppy II Disk Controller is comprised of two basic parts: 1) the hardware board and 2) the software which controls the hardware. The hardware allows the computer to control the drive selection, head loading, track seeks, formatting, reading and writing operations. The software directs the hardware in each of the operations.

The Floppy Disk Controller (FD1797B-2) performs track to track stepping timing, serial to parallel data conversion, parallel to serial data conversion, error code checking and generation, and IBM 3740 soft sector compatible recording. After each operation is completed, the chip interrupts the Central Processing Unit. (The interruption feature is optional.) I/O ports 64, 65, 66 and 67 are contained within the FD1791B-1 device.

The 8 bit Data Out Bus is the S-100 path for transferring data from the Central Processing Unit (CPU) to the output ports on the Versafloppy II board.

The 8 bit Data In Bus is the S-100 path for transferring data from the input ports on the Versafloppy II board to the computer (CPU). The computer makes its selection of the various Input/Output on the board through the eight low order address lines (A0-A7). The I/O

control lines consist of  $\overline{PWR}$ ,  $\overline{PDBIN}$ ,  $\overline{SOUT}$ , and  $\overline{SINP}$ . These lines control the input and output operations to and from the I/O ports on the Versafloppy II.

The on-board Wait State Generator delays the input and output operations until the FD1791B-1 is ready to transfer a word. The  $\overline{PRDY}$  line puts the CPU in a wait state during the delay. Wait states are only generated during sector read and write (port 67).

The Address Decode block detects the presence of a port address on the low order address from the CPU (A0-A7). The output of the Address Decoder is used to gate read and write pulses to the I/O ports.

The Data In Buffer isolates the Bi-Directional Data Bus used on the Versafloppy II from the S-100 Data In Bus. This buffer is enabled during the input port reads from ports on the Versafloppy II.

The Bi-Directional Data Bus is a path for all transfers to and from the Input/Output ports on the Versafloppy II.

The Data Out Buffer isolates the Bi-Directional Data Bus used on the Versafloppy II from the S-100 Data Out Bus. This buffer is enabled except during the input port reads on the Versafloppy II.

The Select Buffer supplies the current sinking drive for the drive and side select lines. The Control Buffer supplies the current sinking drive for WRITE DATA, WRITE GATE, DIRECTION, STEP, TRK43 and HLD. The Sense Buffers receive the READ DATA, INDEX, TRK00, READY and WRTPRP signals from the selected disk drive. Each input is a Schmitt Trigger device providing hysteresis noise immunity.

The Data Separator PLL divides the composite FM and MFMI READ DATA into separated Data and Clock Signals required by the FD1791B-1 Controller Chip.

The Oscillator Circuit provides a crystal controlled squarewave used by the Data Separator and FD1797B-2. This may be software configured for mint or full size disk drive data rates.

## J2 Pin Description

Pin No.	Direction	Signal Name
8	In	IP
10	Out	DRV SEL 1
12	Out	DRV SEL 2
14	Out	DRV SEL 3
16	Out	MOTOR ON (HLD)
18	Out	DIR
20	Out	STEP
22	Out	WRT DATA
24	Out	WRT GATE
26	In	TRK00
28	In	WRT PROT
30	In	RD DATA
32	Out	SIDE SELECT
Odd Pins		GROUND

## J3 Pin Description

Pin No.	Direction	Signal Name
6	Out	GT43
14	Out	SIDE SELECT
18	Out	HLD
20	In	IP
22	In	READY
26	Out	DRV SEL 1
28	Out	DRV SEL 2
30	Out	DRV SEL 3
32	Out	DRV SEL 4
34	Out	DIR
36	Out	STEP
38	Out	WRT DATA
40	Out	WRT GATE
42	In	TRK00
44	In	WRT PROT
46	In	RD DATA
50		GROUND

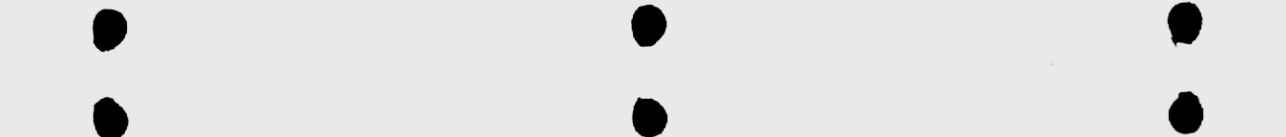

OPERATIONS  
MANUAL

**VERSAFLOPPY II**  
FLOPPY DISK CONTROLLER

VERSAFLOPPY II  
FLOPPY DISK CONTROLLER

COPYRIGHT © 1979  
BY SD SYSTEMS  
JULY 1979

REVISION C  
JULY, 1980

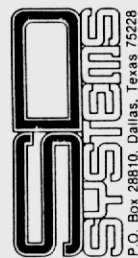

SD #7140043 REV. C

LIMITED WARRANTY

All SD Systems products assembled by SD personnel and functionally tested at our facility are warranted for a period of ninety (90) days from date of purchase to be free from defects of material and workmanship. Kits or other products functionally unfinished or semi-finished at the time of shipment from our facility are warranted for the same period in regard to material defects only, with no warranty, expressed or implied, covering workmanship of others. Should an SD Systems product fail to perform to specifications, obtain a Returned Material Authorization number from your dealer or from SD Systems. Include this number in all correspondence and with the returned product. Ship the item prepaid to SD Systems and it will, at our option, be repaired or replaced free of charge, provided the unit is received during the warranty period. Testing or repair work performed upon returned kits or other products assembled wholly or partially by others will be subject to a \$35.00 minimum service charge unless such products are found to be non-functional due to defects in material purchased from SD Systems.

In order to validate this warranty, the enclosed warranty card must be returned to SD Systems. If no warranty card is on file at the time of product return, dated proof of purchase will be required.

This warranty is invalid if product has been misused or modified. Warranty is limited to replacement of defective parts and no responsibility is assumed for damage to other equipment.

**THERE ARE NO UNDERSTANDINGS, AGREEMENTS, REPRESENTATIONS, OR WARRANTIES, EXPRESSED OR IMPLIED, INCLUDING ANY REGARDING FITNESS FOR A PARTICULAR PURPOSE, NOT SPECIFIED IN THE WARRANTY.**

TABLE OF CONTENTS

SECTION	DESCRIPTION	PAGE
1	GENERAL INFORMATION	1
1-1	INTRODUCTION	1
1-2	GENERAL DESCRIPTION	1
1-3	SOFTWARE CONSIDERATIONS	2
2	FUNCTIONAL DESCRIPTION	3
2-1	INTRODUCTION	3
2-2	FD1791B-1	3
2-3	DATA OUT BUS	3
2-4	DATA IN BUS	4
2-5	A0-A7	4
2-6	I/O CONTROL LINES & READ/WRITE CONTROL	4
2-7	WAIT STATE CONTROL AND PRDY	4
2-8	ADDRESS DECODER	5
2-9	DATA IN BUFFER	5
2-10	DATA OUT BUFFER	5
2-11	BI-DIRECTIONAL DATA BUS	5
2-12	INTERRUPT CONTROL	5
2-13	OUTPUT PORT 63	6
2-14	INPUT PORT 63	6
2-15	SELECT BUFFER	6
2-16	CONTROL BUFFER	6
2-17	SENSE BUFFER	6
2-18	DATA SEPARATOR	6
2-19	OSCILLATOR	7
3	CONTROL SOFTWARE	9
3-1	INTRODUCTION	9
3-2	SECTOR READ SEQUENCE	10
3-3	SECTOR WRITE SEQUENCE	10-11
3-4	DRIVE SELECTION SEQUENCE	12
3-5	TRACK SEEK AND TRANSFER INITIALIZATION	12
3-6	"END OF COMMAND" ROUTINE	13
3-7	FORMAT ROUTINE	13
4	CONSTRUCTION	14
4-1	INTRODUCTION	14
4-2	ASSEMBLY PROCEDURE	14
4-3	VOLTAGE CHECK	15
4-4	PHASE LOCKED OSCILLATOR ADJUSTMENT	16

TABLE OF CONTENTS  
(cont'd)

SECTION	DESCRIPTION	PAGE
5	INTERRUPT OPTIONS	17
5-1	INTRODUCTION	17
6	SOFTWARE OPTIONS	18
6-1	INTRODUCTION	18
6-2	BOOTING UP SDOS	18
7	CHECK OUT	19
7-1	INTRODUCTION	19
7-2	OSCILLATOR	19
7-3	RE AND WE PULSES	19
7-4	I/O POWER WRITE/READ VERIFICATION	19
7-5	HEAD LOAD MONOSTABLE	20
8	DIAGNOSTIC SOFTWARE	21
8-1	INTRODUCTION	21
8-2	DIAGNOSTIC TEST START-UP	21
8-3	DIAGNOSTIC TEST 00 (SEEK TEST)	22
8-4	DIAGNOSTIC TEST 01 (WRITE/READ)	22-23
8-5	DIAGNOSTIC TEST 02 (READ TEST)	23
8-6	DIAGNOSTIC TEST 03 (RANDOM WRITE/READ)	23
8-7	DIAGNOSTIC TEST 04 (MULTI-DRIVE RANDOM WRITE/READ)	23
8-8	DIAGNOSTIC TEST 05 (FORMATTING)	24
8-9	DIAGNOSTIC TEST FF (JUMP)	24
8-10	DIAGNOSTIC ERROR REPORTING	24

APPENDICES

A	VERSAFLOPPY II SCHEMATIC DIAGRAM
B	VERSAFLOPPY II PARTS LIST
C	VERSAFLOPPY II ASSEMBLY DRAWING
D	VERSAFLOPPY II CONTROL SOFTWARE DBBIOS
E	VERSAFLOPPY II DIAGNOSTIC SOFTWARE

SECTION I

GENERAL INFORMATION

1-1 INTRODUCTION

VERSAFLOPPY II™ is the new floppy controller board from SD SYSTEMS. It features the Western Digital FDI795 double density controller. The unique feature of this board is that it may be used with mini or full-size floppy drives, single or double density, single or double sided, in any variation thereof. For example, a mini drive operating single density and a full-size drive operating double density may be utilized at the same time and information may be transferred from one to the other.

VERSAFLOPPY II was designed to be used optimally with SD SYSTEMS' SBC-200, single board computer, and Expandoram boards to form a complete, low cost, disk based computer. The VERSAFLOPPY II is designed for operation with the Z80 CPU and is not recommended for operation with other processors.

1-2 GENERAL DESCRIPTION

At the heart of the VERSAFLOPPY II is the powerful Western Digital FDI795B NMOS LSI double density controller chip. This device performs most of the timing and control functions required by floppy disk drives such as:

1. Head load/unload
2. Track seeking with verification
3. Address mark detection/generation
4. Serial to parallel data conversion during reads
5. Parallel to serial data conversion during writes
6. CRC error code checking/generation
7. IBM 3740 Soft Sector compatible reading
8. Signals for double density recording and precompensation

During sector reading and writing, the data rate is synchronized with the CPU by inserting wait states until the FDI795B is ready for the next word.

The VERSAFLOPPY II employs a phase locked loop in the data recovery circuit which insures a valid readback during double density operation.

#### 1-3 SOFTWARE CONSIDERATIONS

The control function has been designed to be evenly distributed between the hardware circuit and the control software allowing a great deal of flexibility for the user. A version of the control software is supplied with the VERSAFLOPPY II in listing form configured to run on the SBC-100/200 single board computer. This may be modified to meet the user's specific software interface requirements, such as register usage, parameter hand-offs and data formats.

Also available from SD SYSTEMS is a version of SDOS configured to run on the SBC-100/200, VERSAFLOPPY II and 32K Expandoram II board combination. This allows using several disk based versions of high level languages.

## SECTION II FUNCTIONAL DESCRIPTION

### 2-1 INTRODUCTION

Functionally, the VERSAFLOPPY II consists of two main parts: hardware, and the software which controls it. The hardware allows the computer to control the drive selection, head loading, track seeks, formatting, reading and writing operations. The software, as described in Section 3, must direct the hardware in each of these operations. The major functions contained in the VERSAFLOPPY II hardware are shown in the block diagram. (Fig. 2-1) Table 2-1 lists the S-100 Bus signals used by the VERSAFLOPPY II.

### 2-2 FDI791B-1

The FDI797, the floppy disk controller chip, performs track to track stepping timing, head load timing, serial to parallel data conversion; parallel to serial data conversion; error code checking/generation, and IBM 3740 softsector compatible recording. After each operation is completed, the chip can optionally interrupt the CPU. (For complete description, see Western Digital FDI795 specification). I/O ports 64,65,66 and 67 are contained within this device.

The FDI795 also has the necessary signals to implement double density operation including a pin to determine whether the chip is to operate single or double density and a late and an early signal for use in precompensation.. The FDI795

has a negative true data bus.

#### 2-3 DATA OUT BUS

The 8 bit DATA OUT BUS is the S-100 path for transferring data from the computer (CPU) to the output ports on the VERSAFLOPPY II board.

#### 2-4 DATA IN BUS

The 8 bit DATA IN BUS is the S-100 path for transferring data from the input ports on the VERSAFLOPPY II board to the computer (CPU).

#### 2-5 A0-A7

The A0-A7 low order eight address lines are used by the computer (CPU) to select the various input/output ports on the board.

#### 2-6 I/O CONTROL LINES AND READ/WRITE CONTROL

The I/O Control lines consist of PWR, PDBIN, SOUT, SINP. These lines are used to control the input and output operations from/to the I/O ports on the board.

#### 2-7 WAIT STATE CONTROL AND PRDY

The Wait State Generator is used by the VERSAFLOPPY II to delay the input and output operations until the FD1795 chip is ready to transfer a word. This PRDY line puts the CPU in a wait state during the delay. Wait states are only generated during sector reads and writes (which use I/O port 67).

#### 2-8 ADDRESS DECODER

The Address Decoder detects when a port address used on the VERSAFLOPPY II is present on the low order eight bits of address from the CPU (A0-A7). The output of the decoder is used to gate read and write pulses to the I/O ports.

#### 2-9 DATA IN BUFFER

The Data In Buffer isolates the Bi-Directional Data Bus used on the VERSAFLOPPY II from the S-100 Data In Bus. This buffer is enabled during input port reads from ports on the VERSAFLOPPY II. The data is inverted by the Data In Buffer to compensate for the negative true data bus of the FD1795 controller chip.

#### 2-10 DATA OUT BUFFER

The Data Out Buffer isolates the Bi-Directional Data Bus used on the VERSAFLOPPY II from the S-100 Data Out Bus. This buffer is enabled except during input port reads from ports on the VERSAFLOPPY II. The output data is inverted by the Data Out Buffer to compensate for the negative true data bus of the FD1795 controller chip.

#### 2-11 BI-DIRECTIONAL DATA BUS

The Bi-Directional Data Bus is a path for all transfers to and from the I/O ports on the VERSAFLOPPY II.

#### 2-12 INTERRUPT CONTROL

The VERSAFLOPPY II operates with or without interrupts, but the standard control software does not use interrupts.

#### 2-13 OUTPUT PORT 63

Output Port 63 is an 8 bit control register with several functions:

1. Bits 0-3 Drive Select 1,2,3,4
2. Bit 4 Side Select for double sided drives
3. Bit 5 5"/8" drives
4. Bit 6 Double/Single Density
5. Bit 7 Wait State Enable/INUSE STB\*

\*The INUSE STB when set low during drive select activation/deactivation will lock or unlock the drive door if that option is incorporated on the drive. This function can be disabled by cutting the etch between E11 and E12.

#### 2-14 INPUT PORT 63

Input Port 63 is used to read the present state of several control signals:

1. Bits 6-7 State of Output Port 63, as described above

#### 2-15 SELECT BUFFER

The Select Buffer supplies the current sinking drive for the drive and side select lines.

#### 2-16 CONTROL BUFFER

The Control Buffer supplies the current sinking drive for WRITE

DATA, WRITE GATE, DIRECTION, STEP, TRK43, and HLD.

#### 2-17 SENSE BUFFER

The Sense Buffer receives the READ DATA, INDEX, TRK00, READY, and WRTPT signals from the selected disk drive. Each input is a Schmitt Trigger providing hysteresis noise immunity.

#### 2-18 DATA SEPARATOR

The Data Separator circuit divides the composite FM & MFM READ DATA

into separated Data and Clock signals required by the FD1795 controller chip. The data separator uses the 74LS124 VCO coupled with a LM301 OP AMP to dynamically reconstruct the data clock from the input raw data stream.

#### 2-19 OSCILLATOR

The Oscillator circuit provides a crystal controlled squarewave (16MHZ) divided down to provide the proper clock frequency to the FD1795 for 8" or 5 1/4" operation.



TABLE 2-1  
S-100 BUS SIGNALS USED BY VERSAFLOPPY II

PIN	SIGNAL NAME	DIRECTION	DESCRIPTION
1,51	+8Volts		
2	+16 Volts		
6	VI2	OUTPUT	INTERRUPT CHANNEL 2
7	VI3	OUTPUT	INTERRUPT CHANNEL 3
24	$\emptyset 2$	INPUT	PHASE 2 CLOCK
25	$\emptyset 1$	INPUT	PHASE 1 CLOCK
29-31, 79-83	A0-A7	INPUTS	OW ORDER ADDRESS
35, 36, 38-40, 88-90	DO $\emptyset$ -D07	INPUTS	DATA OUT BUS
41-43, 91-95	DI $\emptyset$ -DI7	OUTPUTS	DATA IN BUS
45	SOUT	INPUT	PORT OUTPUT CYCLE
46	SINP	INPUT	PORT INPUT CYCLE
72	PRDY	OUTPUT	READY
77	$\overline{\text{PWR}}$	INPUT	WRITE
78	PDBIN	INPUT	DATA BUS IN
99	$\overline{\text{POC}}$	INPUT	POWER ON CLEAR
100, 50	GROUND		

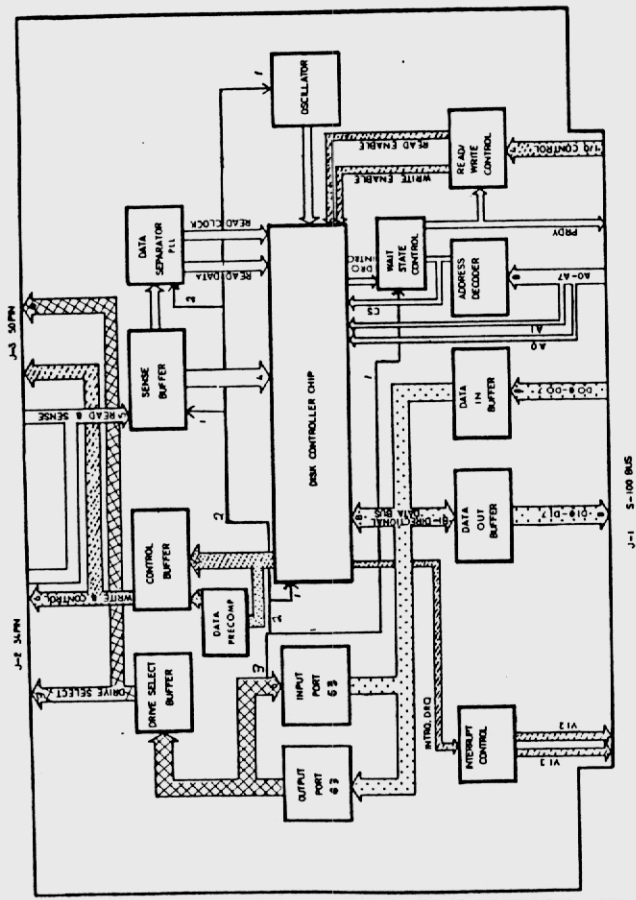

VERSAFLOPPY II BLOCK DIAGRAM

FIGURE 2-1

SECTION III  
CONTROL SOFTWARE

3-1 INTRODUCTION

The versatility of the VERSAFLOPPY II is maintained by its ability to be controlled by software. Certain sequences must be executed to ensure proper operation of the disk drive. These control sequences are supported by the SD SYSTEMS' DBBIOS software program.

This section will cover these basic software sequences with verbal and graphic description. Program listings of the software in Z-80 source code are included in Appendix E.

The SECTOR READ and SECTOR WRITE sequences are the two main entries into the controlling software. Before these sequences may be entered, the memory transfer address, drive select, track, and sector must have been stored in memory locations. When operating with SDOS Disk Operating System, these parameters are set up when the SETDMA, SELDSK, SETTRK, and SETSEC entries, respectively, are called. The READ and WRITE SDOS entries are linkages to the SECTOR READ and SECTOR WRITE sequences, respectively. If an error is encountered in the Read or Write process, two more attempts will be made to execute the process. After this a Rseek will be executed and then three more Retrys. If an error still exists, program control will be returned to the user with the Z bit reset. If no error exists the Z bit will be set upon Return.

3-2 SECTOR READ SEQUENCE (Figure 3-1)

The function of the SECTOR READ SEQUENCE is to do everything necessary to transfer the previously specified sector (128.BYTES) to the previously specified memory buffer (anywhere in the system RAM):

SECTOR READ SEQUENCE  
FIG 3-1

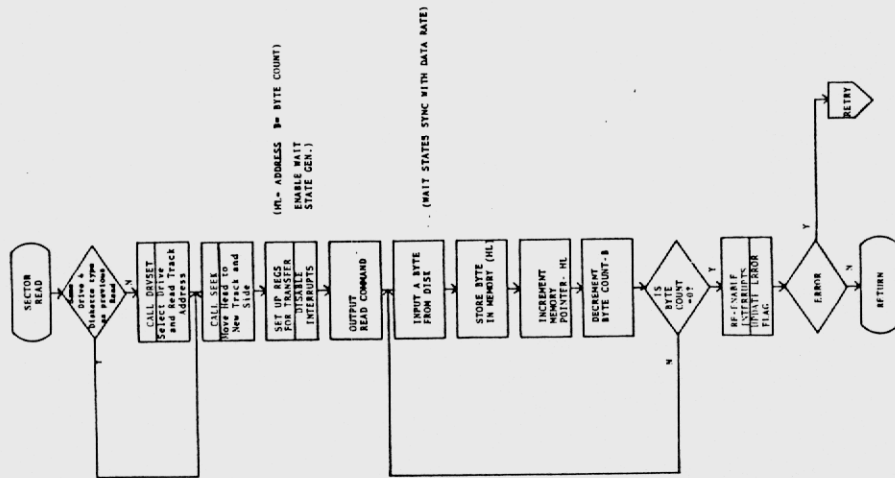

SECTOR READ SEQUENCE

FIGURE 3-1

The UNIT byte is compared to the unit check byte to determine if the desired drive and diskette type is the same as the previously selected drive and diskette type. If not, the DRVSET routine is called to set up the new drive and determine the diskette type table address to be stored in the IX index register. If DRVSET is called then ID READ is also called to set up the track address of the new drive.

The SEEK and TRINT (section 3-5) subroutines are called to put the Read/Write head on the requested side and track.

The CPU registers are then set up with the memory address and byte count. Data from the disk is input a byte at a time, and stored in memory. This process is synchronized with the disk data rate by hardware inserted wait states. (Interrupts are dis-abled during data transfers).

When all 128 bytes of data have been read in, the program waits for the hardware to go "not busy". The End of Command Routine then checks for CRC and other error conditions. If no errors occurred, the program returns to the caller with the error flag cleared.

3-3 SECTOR WRITE SEQUENCE (figure 3-2)

The function of the SECTOR WRITE SEQUENCE is to do everything necessary to transfer the previously specified memory buffer (128 bytes anywhere in the system) to the previously specified disk sector.

The UNIT byte is compared to the unit check byte to determine if the desired drive and diskette type is the same as the previously

SECTOR WRITE SEQUENCE  
FIG. 3-2

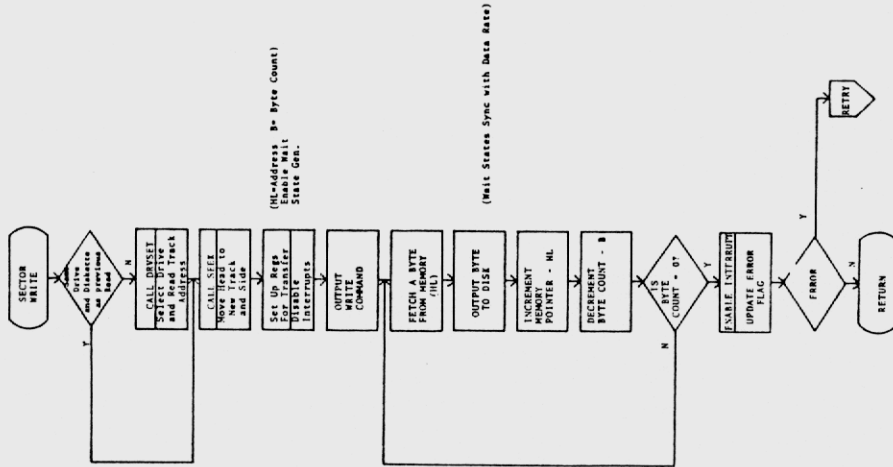

selected drive and diskette type. If not, the DRVSET routine is called to set up the new drive and determine the diskette type table address to be stored in the IX index register. If DRVSET is called then ID READ is also called to set up the track address of the new drive.

The SEEK and TRINT (section 3-5) subroutines are called to put the Read/Write head on the requested side and track.

The CPU registers are then set up with the memory address and byte count. The data is output a byte at a time, to the disk. This process is synchronized with the disk rate by hardware inserted wait states. (Interrupt are disabled during data transfers).

When all 128 bytes of data have been output, the program waits for the hardware to go "not busy". The End of Command Routine then checks for CRC and other error conditions. If no errors occurred, the program returns to the caller with the error flag cleared.

SECTOR WRITE SEQUENCE

Figure 3-2

DRIVE SELECTION SEQUENCE  
FIG 3-3

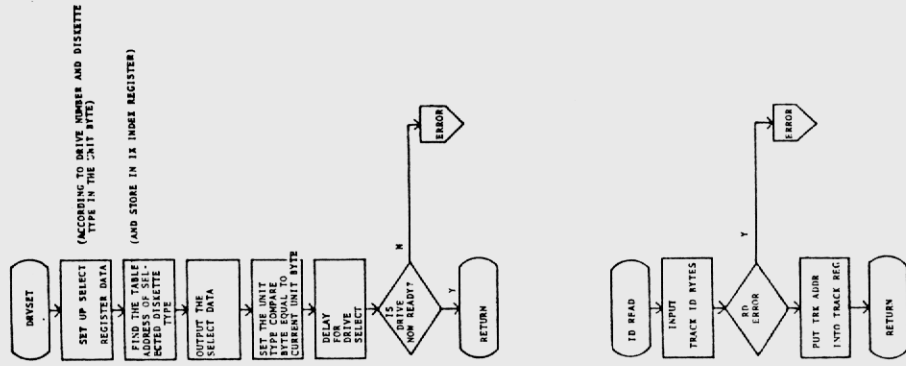

DRIVE SELECTION SEQUENCE

Figure 3-3

### 3-4 DRIVE SELECTION SEQUENCE (Figure 3-3)

The DRIVE SELECTION SEQUENCE translates the data in the unit byte into the format of the select register. The IX index register is then set up with the diskette type table address desired. The new selection is output followed by a delay for Drive Select. This delay is 18 milliseconds for a full-size drive and about 50 milliseconds for a mini.

The status is then read to verify that the drive is ready. If the drive is not ready, the error exit is taken.

### ID READ

In the ID READ ROUTINE the track address is read from the disk to inform the hardware of what track the new drive's read/write head is presently on. The normal return routine is then executed.

### 3-5 TRACK SEEK AND TRANSFER INITIALIZATION

The TRACK SEEK routine moves the head to the proper track, after verifying the track is valid. The TRANSFER INITIALIZATION (TRINT) sequence is responsible for verifying that the requested sector is a valid number and in the case of the double-sided drives, select the proper side of the disk. The Transfer Address is also set up in this routine.

END OF COMMAND ROUTINE  
FIG 3-5

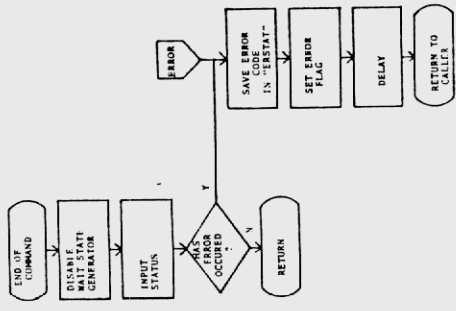

END OF COMMAND ROUTINE  
Figure 3-5

TRACK SEEK AND TRANSFER INITIALIZATION  
FIG 3-4

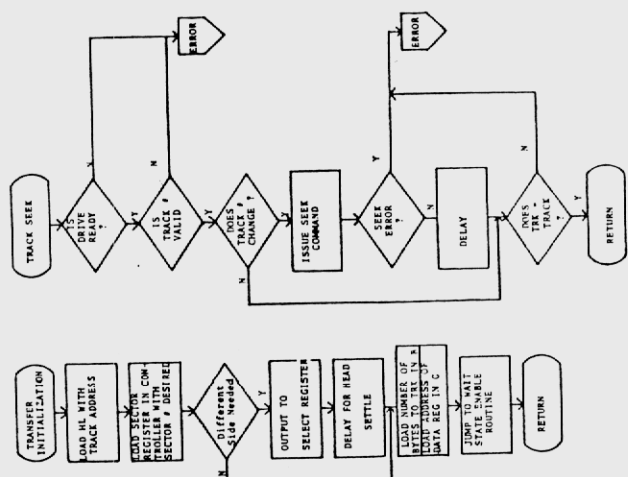

TRACK SEEK  
Figure 3-4

### 3-6 END OF COMMAND ROUTINE (figure 3-5)

The END OF COMMAND ROUTINE is entered after both normal and error terminations of hardware executed commands. The routine waits for the FD1795 to become "not busy". The wait state generator is then disabled, and the status is input to check for errors. If no error occurred, then a normal return is taken.

If an error condition is detected, then error type is saved, error flag set and a return is taken directly back to the caller after a delay (18 MS-8"; 50 MS-5")

### 3-7 FORMAT ROUTINE

The FORMAT ROUTINE is entered directly through the vector at location F033. This routine expects the UNIT byte to be set up previously according to the type of format desired. See Table 8-1 for valid UNIT byte data.

NOTE 1: The DDBIOS software uses the side byte on the diskette to determine if the diskette is single or double sided. It therefore may mis-read disks formatted double-sided on an SD-100 as single-sided.

NOTE 2: Early boards used a 1791B-1 controller chip, which is not able to read disks formatted with all zeros in the gaps between sectors. Therefore, VersaFloppy II boards with the 1791B-1 cannot read disks formatted by machines with a 1771 controller chip (like the S.D. Systems SD-100).

## SECTION IV

### CONSTRUCTION

#### 4-1 INTRODUCTION

The SD SYSTEMS VERSAFLOPPY II kit is intended for those people who have had some prior experience with kit building and digital electronics. If you do not fall into this category it is highly recommended that you find an experienced person to help you in assembly and check out of the board.

Appendix B shows the parts list for the SD SYSTEMS Floppy Disk Controller board. Double check all parts against this parts list.

#### 4-2 ASSEMBLY PROCEDURE

1. Install and solder the IC sockets in their proper locations as follows: (Do not install sockets in U1 or U2)  
14 Pin at U4, 8, 11, 12, 14-18, 21-26, 32-34  
16 Pin at U5, 7, 13, 19, 20  
20 Pin at U9, 27-31  
40 Pin at U10
2. Install and solder the resistors as follows: All are  $\frac{1}{4}W$ , 1% (except as noted) and the values are given in Ohms.

A.	R15	120	(Brown, Red, Brown)	5%
B.	R3, R6, R7, R8, R9	150	(Brown, Green, Brown)	5%
C.	R31	200		
D.	R32	301		
E.	R33	680		
F.	R4, R22	1K	(Blue, Gray, Brown)	5%
H.	R19	1.1K	(Brown, Black, Red)	
I.	R16, R24	2.2K	(pot)	
J.	R29, R30	4.22K	(Red, Red, Red)	5%
K.	R2, R23	5.11K		
L.	R13	5.6K	(Green, Blue, Red)	5%
M.	R25	7.32K		
N.	R5, R11, R12	10K	(Brown, Black, Orange)	5%
O.	R1, R27	15K		
P.	R10	47K	(Yellow, Violet, Orange)	5%
O.	R18, R26	100K		
R.	R17, R21	9.094K		

3. Install and solder diodes with the banded end as shown on the PC board.

- A. Install and solder CR1 Zener Diode 1N4742A-12V
- B. Install and solder CR2, CR3 Diode 1N270
- C. Install and solder CR4-CR6 Diodes 1N914
- D. Install and solder CR7 5V Zener Diode 1N751A

4. Install and solder the capacitors as follows:

- A. C1, C27 .047 MF
- B. C2, C28 .015 MF
- C. C3 150 pf
- D. C4-C13, C16, C20-C26, C32, C35-37 .1 uf
- E. C14, C17-C19, C34 10 MF
- F. C15 47uf
- G. C29 100 pf
- H. C30 .001 MF
- I. C31 4.7 MF
- J. C33 47 pf

5. Install and solder the voltage regulator with the heatsink using the 6-32 hardware supplied.

VRI +5V 7805 or LM340T-5

6. Install the W/W pins in TP 1-TP 3 and TP 5.

7. Install and solder 100 UH RF choke.

8. Install and solder J2 (34 pin) and J3 (50 pin) connectors.

9. Double check all solder connections for cold solder joints, unsoldered connections or shorted connections.

#### 4-3 VOLTAGE CHECK

1. Install the board in the computer and measure the output of +5V regulator VRI and +12V of CR1.

VRI = +5V (Pin 3)  
CR1 = +12V (Cathode)

2. Measure the power supply voltages in the Floppy Disk Controller chip.

A. Pin 21 U16 = +5V  
B. Pin 40 U16 = +12V

NOTE: Do not proceed with the board check out until all power supply voltages are correct. The TTL and MOS logic can be permanently damaged if improper voltages are applied.

3. Install the IC's in their sockets observing the PIN 1 designation on each socket marked on the PC board. NOTE: U10'S ORIENTATION IS DIFFERENT FROM THE OTHER IC'S. Also, on U1 the manufacturer's symbol designates Pin 1. On U2 the dot below the triangle designates the corner of the chip that contains pin 1.

- A. U21 74LS00
- B. U23, U33 74LS02
- C. U8, U32 7406
- D. U14 74LS09
- E. U24, U26 74LS10
- F. U11, U15, U17 74LS14
- G. U16 74LS21
- H. U12 74LS32
- I. U22, U25, U34 74LS74
- J. U4, U18 74LS93
- K. U6 74LS112
- L. U13 74LS124
- M. U5 74LS153
- N. U20 74LS157
- O. U7, U19 74LS221
- P. U28, U29 74LS240
- Q. U9, U27, U30 74LS244
- R. U31 74LS273
- S. U10 FD1795B
- T. U3 LM 301 AN

4. Install and solder delay line (DDU-4-2400) in location U2.

5. Install and solder 16MHZ oscillator in location U1.

6. Install PCB ejectors using mounting pins (see Assembly Drawing).

#### 4-4 PHASE LOCKED OSCILLATOR ADJUSTMENT

1. Connect an oscilloscope probe to TP 3.

2. Set the timebase to display 500NS/DIV.

3. Adjust the variable resistor R-19 until there are 10 pulses displayed on the oscilloscope screen.

4. Adjust the variable resistor R-19 until the leading edge of the first pulse is exactly lined up on the first division line on the oscilloscope screen and the trailing edge of the last pulse is exactly lined upon the last division line on the oscilloscope screen.



NOTE: Do not proceed with the board check out until all power supply voltages are correct. The TTL and MOS logic can be permanently damaged if improper voltages are applied.

3. Install the IC's in their sockets observing the PIN 1 designation on each socket marked on the PC board. NOTE: U10'S ORIENTATION IS DIFFERENT FROM THE OTHER IC'S. Also, on U1 the manufacturer's symbol designates Pin 1. On U2 the dot below the triangle designates the corner of the chip that contains pin 1.

A. U21  
B. U23, U33  
C. U8, U32  
D. U14  
E. U24, U26  
F. U11, U15, U17  
G. U16  
H. U12  
I. U22, U25, U34  
J. U4, U18  
K. U6  
L. U13  
M. U5  
N. U20  
O. U7, U19  
P. U28, U29  
Q. U9, U27, U30  
R. U31  
S. U10  
T. U3

74LS00  
74LS02  
7406  
74LS09  
74LS10  
74LS14  
74LS21  
74LS32  
74LS74  
74LS93  
74LS112  
74LS124  
74LS153  
74LS157  
74LS221  
74LS240  
74LS244  
74LS273  
FD1795B  
LM 301 AN

4. Install and solder delay line (DDU-4-2400) in location U2.
5. Install and solder 16MHZ oscillator in location U1.
6. Install PCB ejectors using mounting pins (see Assembly Drawing).

#### 4-4 PHASE LOCKED OSCILLATOR ADJUSTMENT

1. Connect an oscilloscope probe to TP 3.
2. Set the timebase to display 500NS/DIV.
3. Adjust the variable resistor R-19 until there are 10 pulses displayed on the oscilloscope screen.
4. Adjust the variable resistor R-19 until the leading edge of the first pulse is exactly lined up on the first division line on the oscilloscope screen and the trailing edge of the last pulse is exactly lined upon the last division line on the oscilloscope screen.

## SECTION V

### INTERRUPT OPTIONS

#### 5-1 INTRODUCTION

There are basically two possible methods of handling interrupts with the VERSAFLOPPY II:

1. Interrupts are not used. (Standard Software)
2. Z-80 Mode 2 using CTC interrupt circuit on SBC-100/200

The Standard Control Software does not use interrupts. However in some cases it may be beneficial to issue a command (such as SEEK TRACK) and be interrupted when it is complete.

## SECTION VI

### SOFTWARE OPTIONS

#### 6-1 INTRODUCTION

The standard control software for the VERSAFLOPPY II is supplied in listing form (Appendix D) and also available in 2716 PROM for an additional charge. This software is called DDBIOS (Double Density Basic I/O System) and is assembled to reside at F000H.

#### 6-2 BOOTING UP THE SDOS

In order to run SDOS, a minimum of 16K of RAM must be in the system starting at address 0000 and the BIOS PROM must be at F000H. Execute BIOS at F000 and SDOS will be booted and prompt with "[A]". Refer to the "SD SYSTEMS DISK OPERATING SYSTEM (SDOS) USER'S GUIDE" for details of the SDOS commands.

## SECTION VII

### CHECK - OUT

#### 7-1 INTRODUCTION

This section will describe some basic checks that should be made on the VERSAFLOPPY II. NOTE: It is assumed at this point that the voltage checks described in Section 4 have been previously made. The following checks require that the CPU board also be plugged into the Bus.

#### 7-2 OSCILLATOR

Apply power to board and verify that there is a 10MHZ clock on U9 - Pin 3.

#### 7-3 RE AND WE PULSES

Verify that U10 Pin 4 pulses low during any Input instruction, and U10 Pin 2 pulses low during any output instruction.

#### 7-4 I/O PORT WRITE/READ VERIFICATION

Using the monitor in the system or a short program, write data to port 65 and read it back. Verify that the data read back is the same as that written. This is done to test the data path to and from the FDI791B-1 as well as the internal register. REPEAT this procedure for ports 66, 67 and 63.

SECTION VIII  
DIAGNOSTIC SOFTWARE

7-5 HEAD LOAD MONOSTABLE

After the diagnostic software is operating, check U20-Pin 3 for a 35 millisecond pulse (low) and U20-Pin 2 for 1.5 sec pulse (low) each time the head loads.

8-1 INTRODUCTION

A diagnostic program for the VERSAFLOPPY II is supplied in the top of the 2716 DDBIOS PROM. The diagnostic program is also on the diskette, when SDOS is purchased, under the file name of "VFDIAG.COM". Once SDOS is operating, the diagnostic may be run by typing VFDIAG (CR). THE SDOS DISKETTE SHOULD NOT BE PLACED IN THE DRIVE UNTIL THE VERSAFLOPPY II AND DISK DRIVES HAVE BEEN THOROUGHLY CHECKED OUT.

When running the diagnostic to check-out the VERSAFLOPPY-II, execute the program starting at address F600. The diagnostic uses the DDBIOS and monitor PROMS for disk and console I/O.

8-2 DIAGNOSTIC TEST START-UP

Upon executing the diagnostic program the following message will print on the console:

TEST# DRV# (TTDD)

The program then waits for the test number and drive number to be entered from the console followed by a carriage return.

NOTE: The test number and drive number are each two digits and MUST NOT be separated by a comma or space. Table 8-1 shows drive numbers.

Type Drive	#Sides Disk Size Density	1		2		1		2		1		2	
		Full Single	Full Double	Mini Single	Mini Double	Full Single	Full Double	Mini Single	Mini Double	Full Single	Full Double	Mini Single	Mini Double
A		00	10	20	30	40	50	60	70				
B		01	11	21	31	41	51	61	71				
C		02	12	22	32	42	52	62	72				
D		03	13	23	33	43	53	63	73				

TABLE 8-1

Note that these unit numbers must also be used with R, W and Z commands in the SD Monitor.

The test routines (except for 05) may be terminated at any time by entering a period (.) on the console keyboard. The diagnostic will then print the above prompting message and wait for further keyboard entries. If the period (.) is entered instead of a command, control will be transferred to the monitor.

8-3 DIAGNOSTIC TEST 00 (SEEK TEST)

Test 00 is a simple routine to verify that the VERSAFLOPPY II is receiving commands properly and that the track seek circuitry is functional. The selected drive should begin moving the head from track 00 to the inside track (76 for full size, 34 for mini) and back again. Enter a period on the keyboard to cause the test to cease.

8-4 DIAGNOSTIC TEST 01 (WRITE/READ)

Diagnostic test 01 writes random data on each sector, reads the

sector back and compares the data to verify that it is identical. Any errors which occur will be printed on the console. (see Section 8) This is done to each sector sequentially, starting at track 00, sector 1, until reaching the innermost track. At that point it prints a "p" on the console, returns to track 00, and continues.

NOTE: Diagnostic tests which read and write to disk may only be run after the diskette has been formatted using diagnostic 05. (see 8-8)

8-5 DIAGNOSTIC TEST 02 (READ TEST)

Test 02 reads every sector on the disk sequentially and checks for CRC errors, and seek errors. Errors will be reported on the console. This test should step from track to track at the same rate as when formatting a diskette.

8-6 DIAGNOSTIC TEST 03 (RANDOM WRITE/READ)

This test is similar to test 01 in that it writes, reads and compares data byte by byte. However, test 03 chooses the sectors and tracks on a random basis in an attempt to simulate actual use. This test exercises only on the specified drive.

8-7 DIAGNOSTIC TEST 04 (MULTI-DRIVE RANDOM WRITE/READ)

This test is identical to test 03 except that it also selects a random drive (0 or 1).

8-8 DIAGNOSTIC TEST 05 (FORMATTING)

Test 05 is actually not a diagnostic, but a program which formats a diskette in accordance with drive and density type. This must be done to all diskettes before further use. Note that on the distributed SDOS diskette there is a program which formats a diskette. This program has the filename "FORMAT.COM" and may be run by entering "FORMAT (CR)". BE SURE TO USE A SCRATCH OR UNFORMATTED DISKETTE WHEN FORMATTING BECAUSE ANY PREVIOUSLY WRITTEN DATA WILL BE LOST.

8-9 DIAGNOSTIC TEST FF (JUMP)

Test code FF allows exiting the diagnostic to anywhere in memory. The following sequence describes this:

CONSOLE INTERACTION

TEST # DRV # (TTDD) : FF00 (CR)  
ADDRESS: 3000 (CR)

COMMENTS

Jump to address 3000H

8-10 DIAGNOSTIC ERROR REPORTING

If any errors occur during diagnostics 1,2,3, or 4, the errors will be reported on the console as follows:

CMD STAT DRV TRK SCIR CC SS DD TT SS

where CC = The controller command being executed  
SS = The error status (type of error)  
DD = The drive being tested  
TT = The track being tested  
SS = The sector being tested

Table 8-1 lists all the various controller commands and Table 8-2 contains the definition of each bit in the error status byte.

TABLE 8-1  
DISK CONTROLLER COMMAND CODES

MINI DISK CMD CODE	FULL SIZE CMD CODE	DESCRIPTION
0B	09	Restore Drive TRK 00
13	19	Track Seek with No Verify
F4	F4	Format Track
88	80	Read Sector
A8	A0	Write Sector
C4	C0	Read Track Address

TABLE 8-2  
ERROR STATUS DEFINITION

BIT #	DEFINITION
BIT 0	Busy
BIT 1	DRQ Bit (Indicates Excessive noise on S-100 Bus)
BIT 2	Data Lost
BIT 3	CRC Error
BIT 4	Sector Not Found
BIT 5	Track Seek Error
BIT 6	Write Protected Diskette
BIT 7	Drive Not Ready
FE	Controller Hang Up
0F	Invalid, Track Error

U2  
DATA DELAY  
000-1-2400

U11  
U12

U10  
U21  
U22

TP5  
R7  
U9  
C11  
R8  
R11  
R12  
U20

U18  
U17  
U16  
U15  
U14  
U13  
U12  
U11  
U10  
U9  
U8  
U7  
U6  
U5  
U4

TP2  
TP3  
TP4  
U6  
U5  
U4

U33  
U32  
U31  
U30  
U29  
U28  
U27  
U26  
U25  
U24  
U23  
U22

U21  
U20  
U19  
U18  
U17  
U16  
U15  
U14  
U13  
U12  
U11  
U10  
U9  
U8  
U7  
U6  
U5  
U4  
U3  
U2  
U1

U1  
U2  
U3  
U4  
U5  
U6  
U7  
U8  
U9  
U10  
U11  
U12  
U13  
U14  
U15  
U16  
U17  
U18  
U19  
U20  
U21  
U22  
U23  
U24  
U25  
U26  
U27  
U28  
U29  
U30  
U31  
U32  
U33

ASSY 0100150  
REV C

U30  
U31

U32  
U33

U34  
U35

U36  
U37  
U38  
U39

U40  
U41  
U42  
U43  
U44  
U45  
U46  
U47  
U48  
U49  
U50

U51  
U52  
U53  
U54  
U55  
U56  
U57  
U58  
U59  
U60

U61  
U62  
U63  
U64  
U65  
U66  
U67  
U68  
U69  
U70

U71  
U72  
U73  
U74  
U75  
U76  
U77  
U78  
U79  
U80

U81  
U82  
U83  
U84  
U85  
U86  
U87  
U88  
U89  
U90

U91  
U92  
U93  
U94  
U95  
U96  
U97  
U98  
U99  
U100

U101  
U102  
U103  
U104  
U105  
U106  
U107  
U108  
U109  
U110

U111  
U112  
U113  
U114  
U115  
U116  
U117  
U118  
U119  
U120

U121  
U122  
U123  
U124  
U125  
U126  
U127  
U128  
U129  
U130

U131  
U132  
U133  
U134  
U135  
U136  
U137  
U138  
U139  
U140

U141  
U142  
U143  
U144  
U145  
U146  
U147  
U148  
U149  
U150

U151  
U152  
U153  
U154  
U155  
U156  
U157  
U158  
U159  
U160

U161  
U162  
U163  
U164  
U165  
U166  
U167  
U168  
U169  
U170

U171  
U172  
U173  
U174  
U175  
U176  
U177  
U178  
U179  
U180

U181  
U182  
U183  
U184  
U185  
U186  
U187  
U188  
U189  
U190

U191  
U192  
U193  
U194  
U195  
U196  
U197  
U198  
U199  
U200

U201  
U202  
U203  
U204  
U205  
U206  
U207  
U208  
U209  
U210

U211  
U212  
U213  
U214  
U215  
U216  
U217  
U218  
U219  
U220

U221  
U222  
U223  
U224  
U225  
U226  
U227  
U228  
U229  
U230

U231  
U232  
U233  
U234  
U235  
U236  
U237  
U238  
U239  
U240

U241  
U242  
U243  
U244  
U245  
U246  
U247  
U248  
U249  
U250

U251  
U252  
U253  
U254  
U255  
U256  
U257  
U258  
U259  
U260

U261  
U262  
U263  
U264  
U265  
U266  
U267  
U268  
U269  
U270

U271  
U272  
U273  
U274  
U275  
U276  
U277  
U278  
U279  
U280

U281  
U282  
U283  
U284  
U285  
U286  
U287  
U288  
U289  
U290

U291  
U292  
U293  
U294  
U295  
U296  
U297  
U298  
U299  
U300

U301  
U302  
U303  
U304  
U305  
U306  
U307  
U308  
U309  
U310

U311  
U312  
U313  
U314  
U315  
U316  
U317  
U318  
U319  
U320

U321  
U322  
U323  
U324  
U325  
U326  
U327  
U328  
U329  
U330

U331  
U332  
U333  
U334  
U335  
U336  
U337  
U338  
U339  
U340

U341  
U342  
U343  
U344  
U345  
U346  
U347  
U348  
U349  
U350

U351  
U352  
U353  
U354  
U355  
U356  
U357  
U358  
U359  
U360

U361  
U362  
U363  
U364  
U365  
U366  
U367  
U368  
U369  
U370

U371  
U372  
U373  
U374  
U375  
U376  
U377  
U378  
U379  
U380

U381  
U382  
U383  
U384  
U385  
U386  
U387  
U388  
U389  
U390

U391  
U392  
U393  
U394  
U395  
U396  
U397  
U398  
U399  
U400

U401  
U402  
U403  
U404  
U405  
U406  
U407  
U408  
U409  
U410

U411  
U412  
U413  
U414  
U415  
U416  
U417  
U418  
U419  
U420

U421  
U422  
U423  
U424  
U425  
U426  
U427  
U428  
U429  
U430

U431  
U432  
U433  
U434  
U435  
U436  
U437  
U438  
U439  
U440

U441  
U442  
U443  
U444  
U445  
U446  
U447  
U448  
U449  
U450

U451  
U452  
U453  
U454  
U455  
U456  
U457  
U458  
U459  
U460

U461  
U462  
U463  
U464  
U465  
U466  
U467  
U468  
U469  
U470

U471  
U472  
U473  
U474  
U475  
U476  
U477  
U478  
U479  
U480

U481  
U482  
U483  
U484  
U485  
U486  
U487  
U488  
U489  
U490

U491  
U492  
U493  
U494  
U495  
U496  
U497  
U498  
U499  
U500

U501  
U502  
U503  
U504  
U505  
U506  
U507  
U508  
U509  
U510

U511  
U512  
U513  
U514  
U515  
U516  
U517  
U518  
U519  
U520

U521  
U522  
U523  
U524  
U525  
U526  
U527  
U528  
U529  
U530

U531  
U532  
U533  
U534  
U535  
U536  
U537  
U538  
U539  
U540

U541  
U542  
U543  
U544  
U545  
U546  
U547  
U548  
U549  
U550

U551  
U552  
U553  
U554  
U555  
U556  
U557  
U558  
U559  
U560

U561  
U562  
U563  
U564  
U565  
U566  
U567  
U568  
U569  
U570

U571  
U572  
U573  
U574  
U575  
U576  
U577  
U578  
U579  
U580

U581  
U582  
U583  
U584  
U585  
U586  
U587  
U588  
U589  
U590

U591  
U592  
U593  
U594  
U595  
U596  
U597  
U598  
U599  
U600

U601  
U602  
U603  
U604  
U605  
U606  
U607  
U608  
U609  
U610

U611  
U612  
U613  
U614  
U615  
U616  
U617  
U618  
U619  
U620

U621  
U622  
U623  
U624  
U625  
U626  
U627  
U628  
U629  
U630

U631  
U632  
U633  
U634  
U635  
U636  
U637  
U638  
U639  
U640

U641  
U642  
U643  
U644  
U645  
U646  
U647  
U648  
U649  
U650

U651  
U652  
U653  
U654  
U655  
U656  
U657  
U658  
U659  
U660

U661  
U662  
U663  
U664  
U665  
U666  
U667  
U668  
U669  
U670

U671  
U672  
U673  
U674  
U675  
U676  
U677  
U678  
U679  
U680

U681  
U682  
U683  
U684  
U685  
U686  
U687  
U688  
U689  
U690

U691  
U692  
U693  
U694  
U695  
U696  
U697  
U698  
U699  
U700

U701  
U702  
U703  
U704  
U705  
U706  
U707  
U708  
U709  
U710

U711  
U712  
U713  
U714  
U715  
U716  
U717  
U718  
U719  
U720

U721  
U722  
U723  
U724  
U725  
U726  
U727  
U728  
U729  
U730

U731  
U732  
U733  
U734  
U735  
U736  
U737  
U738  
U739  
U740

U741  
U742  
U743  
U744  
U745  
U746  
U747  
U748  
U749  
U750

U751  
U752  
U753  
U754  
U755  
U756  
U757  
U758  
U759  
U760

U761  
U762  
U763  
U764  
U765  
U766  
U767  
U768  
U769  
U770

U771  
U772  
U773  
U774  
U775  
U776  
U777  
U778  
U779  
U780

U781  
U782  
U783  
U784  
U785  
U786  
U787  
U788  
U789  
U790

U791  
U792  
U793  
U794  
U795  
U796  
U797  
U798  
U799  
U800

U801  
U802  
U803  
U804  
U805  
U806  
U807  
U808  
U809  
U810

U811  
U812  
U813  
U814  
U815  
U816  
U817  
U818  
U819  
U820

U821  
U822  
U823  
U824  
U825  
U826  
U827  
U828  
U829  
U830

U831  
U832  
U833  
U834  
U835  
U836  
U837  
U838  
U839  
U840

U841  
U842  
U843  
U844  
U845  
U846  
U847  
U848  
U849  
U850

U851  
U852  
U853  
U854  
U855  
U856  
U857  
U858  
U859  
U860

U861  
U862  
U863  
U864  
U865  
U866  
U867  
U868  
U869  
U870

U871  
U872  
U873  
U874  
U875  
U876  
U877  
U878  
U879  
U880

U881  
U882  
U883  
U884  
U885  
U886  
U887  
U888  
U889  
U890

U891  
U892  
U893  
U894  
U895  
U896  
U897  
U898  
U899  
U900

U901  
U902  
U903  
U904  
U905  
U906  
U907  
U908  
U909  
U910

U911  
U912  
U913  
U914  
U915  
U916  
U917  
U918  
U919  
U920

U921  
U922  
U923  
U924  
U925  
U926  
U927  
U928  
U929  
U930

U931  
U932  
U933  
U934  
U935  
U936  
U937  
U938  
U939  
U940

U941  
U942  
U943  
U944  
U945  
U946  
U947  
U948  
U949  
U950

U951  
U952  
U953  
U954  
U955  
U956  
U957  
U958  
U959  
U960

U961  
U962  
U963  
U964  
U965  
U966  
U967  
U968  
U969  
U970

U971  
U972  
U973  
U974  
U975  
U976  
U977  
U978  
U979  
U980

U981  
U982  
U983  
U984  
U985  
U986  
U987  
U988  
U989  
U990

U991  
U992  
U993  
U994  
U995  
U996  
U997  
U998  
U999  
U1000

U1001  
U1002  
U1003  
U1004  
U1005  
U1006  
U1007  
U1008  
U1009  
U1010

U1011  
U1012  
U1013  
U1014  
U1015  
U1016  
U1017  
U1018  
U1019  
U1020

U1021  
U1022  
U1023  
U1024  
U1025  
U1026  
U1027  
U1028  
U1029  
U1030

U1031  
U1032  
U1033  
U1034  
U1035  
U1036  
U1037  
U1038  
U1039  
U1040

U1041  
U1042  
U1043  
U1044  
U1045  
U1046  
U1047  
U1048  
U1049  
U1050

U1051  
U1052  
U1053  
U1054  
U1055  
U1056  
U1057  
U1058  
U1059  
U1060

U1061  
U1062  
U1063  
U1064  
U1065  
U1066  
U1067  
U1068  
U1069  
U1070

U1071  
U1072  
U1073  
U1074  
U1075  
U1076  
U1077  
U1078  
U1079  
U1080

U1081  
U1082  
U1083  
U1084  
U1085  
U1086  
U1087  
U1088  
U1089  
U1090

U1091  
U1092  
U1093  
U1094  
U1095  
U1096  
U1097  
U1098  
U1099  
U1100

U1101  
U1102  
U1103  
U1104  
U1105  
U1106  
U1107  
U1108  
U1109  
U1110

U1111  
U1112  
U1113  
U1114  
U1115  
U1116  
U1117  
U1118  
U1119  
U1120

U1121  
U1122  
U1123  
U1124  
U1125  
U1126  
U1127  
U1128  
U1129  
U1130

U1131  
U1132  
U1133  
U1134  
U1135  
U1136  
U1137  
U1138  
U1139  
U1140

U1141  
U1142  
U1143  
U1144  
U1145  
U1146  
U1147  
U1148  
U1149  
U1150

U1151  
U1152  
U1153  
U1154  
U1155  
U1156  
U1157  
U1158  
U1159  
U1160

U1161  
U1162  
U1163  
U1164  
U1165  
U1166  
U1167  
U1168  
U1169  
U1170

U1171  
U1172  
U1173  
U1174  
U1175  
U1176  
U1177  
U1178  
U1179  
U1180

U1181  
U1182  
U1183  
U1184  
U1185  
U1186  
U1187  
U1188  
U1189  
U1190

U1191  
U1192  
U1193  
U1194  
U1195  
U1196  
U1197  
U1198  
U1199  
U1200

U1201  
U1202  
U1203  
U1204  
U1205  
U1206  
U1207  
U1208  
U1209  
U1210

U1211  
U1212  
U1213  
U1214  
U1215  
U1216  
U1217  
U1218  
U1219  
U1220

U1221  
U1222  
U1223  
U1224  
U1225  
U1226  
U1227  
U1228  
U1229  
U1230

U1231  
U1232  
U1233  
U1234  
U1235  
U1236  
U1237  
U1238  
U1239  
U1240

U1241  
U1242  
U1243  
U1244  
U1245  
U1246  
U1247  
U1248  
U1249  
U1250

U1251  
U1252  
U1253  
U1254  
U1255  
U1256  
U1257  
U1258  
U1259  
U1260

U1261  
U1262  
U1263  
U1264  
U1265  
U1266



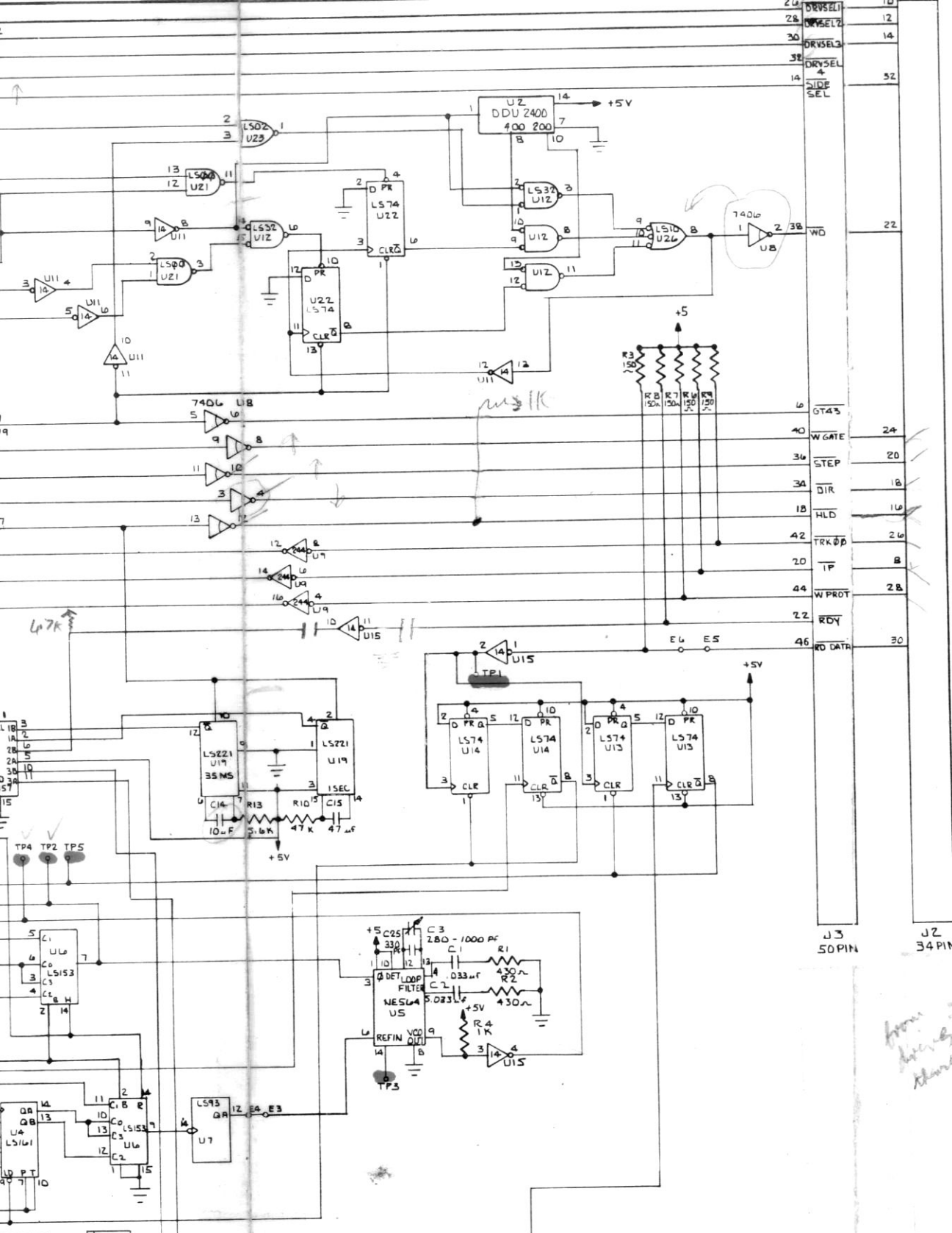

24	DRVSEL1	12
28	DRVSEL2	12
30	DRVSEL3	14
38	DRVSEL4	14
4	SLIP SEL	52
6	ST45	24
40	WGATE	24
36	STEP	20
34	DIR	18
18	HLD	16
42	TRK DP	26
20	TF	8
44	WPROT	28
22	RDY	30
46	RD DATA	30
J3	50 PIN	
J2	34 PIN	

*from  
discuss  
show*

		TOLERANCES .XX = ±.020 ANGLE .XXX = ±.010 ±1/2 .XXXX = ±.005	DRAWN BY J. J. J.
		MATERIAL	CHECKED BY
			DESIGN ENGR
			PROJ ENGR
		FINISH	APPROVED
NEXT ASSY	USED ON		
APPLICATION			



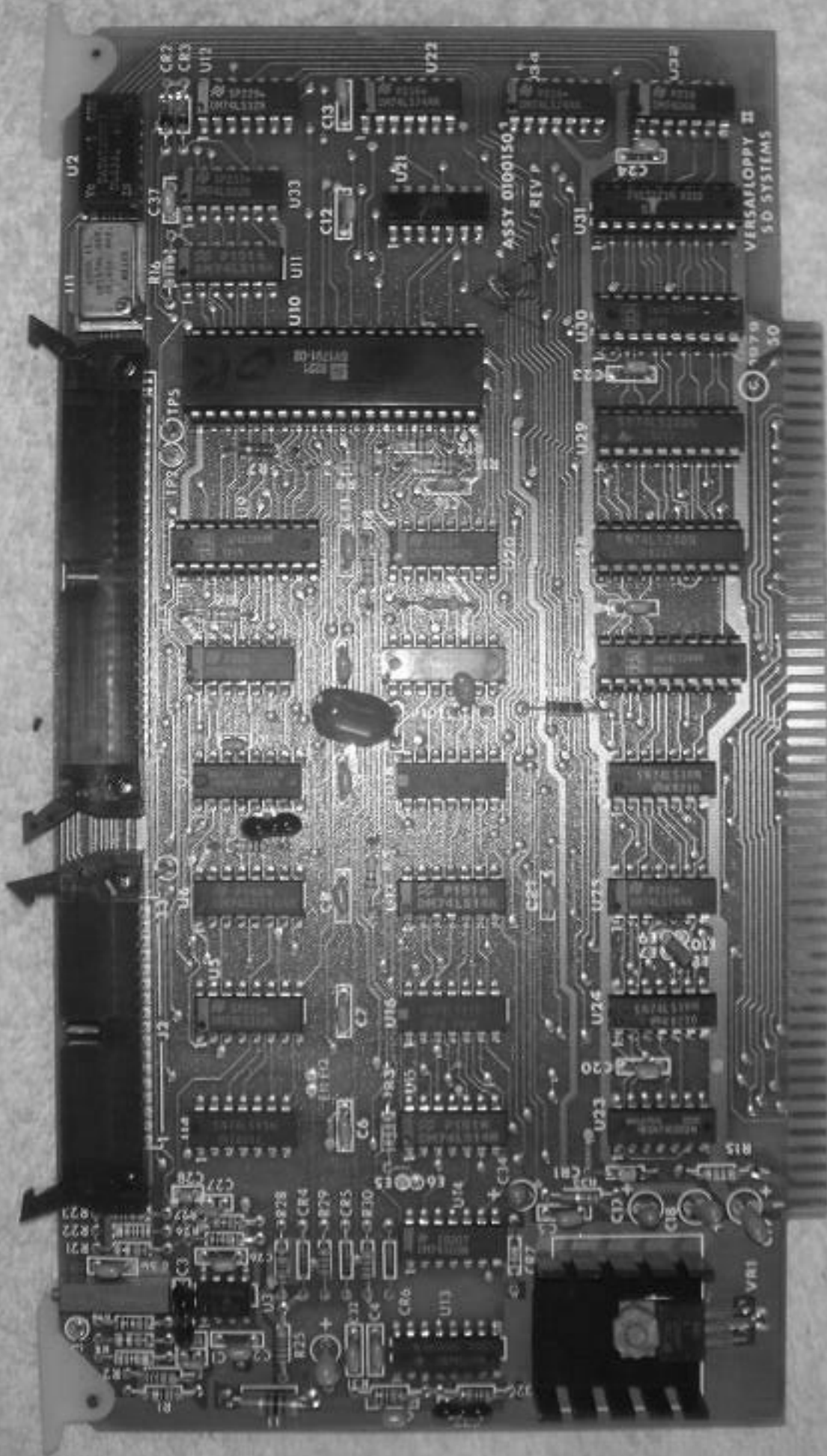

REV	DESCRIPTION	DATE	APP

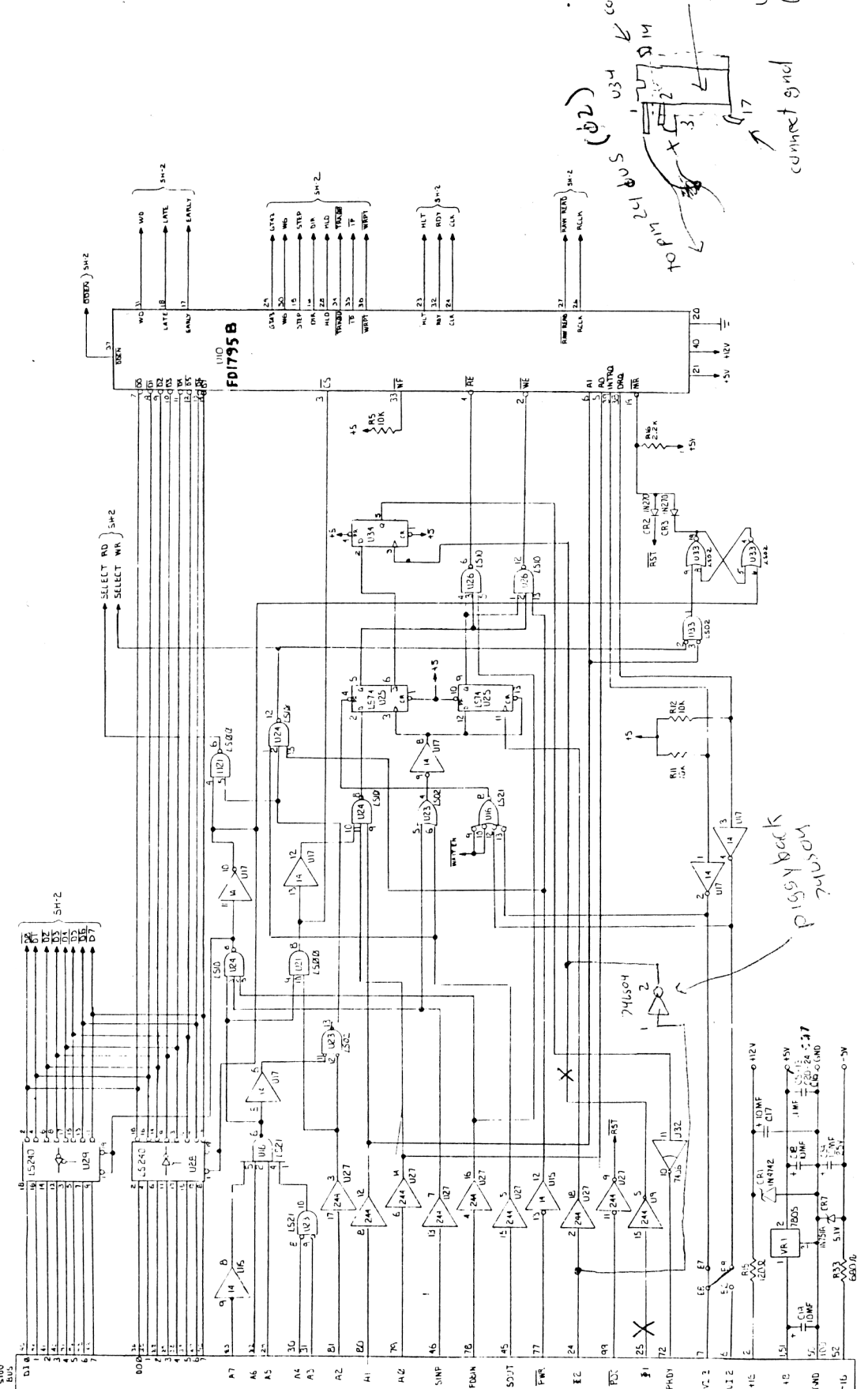

SD SYSTEMS SARLAND, TEXAS			
DATE	DATE	DATE	DATE
DRAWN BY	DESIGNED BY	DESIGN ENGR	APPROVED
VERSAFLOPPY II			
SCHEMATIC			
SIZE CODE	DRAWING NO.	REV	REV
D	0100151	0	K
SCALE	DO NOT SCALE DRAWING	SHEET	OF 2

TOLERANCES		DATE	DATE
XX ± 0.00 ANGLE	XX ± 0.00	DATE	DATE
XXX ± 0.00	XXX ± 0.00	DATE	DATE
MATERIAL			
FINISH	USED ON	APPLICATION	
NEXT ASSY	USED ON	APPLICATION	

RESISTORS ARE 1/4 WATT 5% EXCEPT AS NOTED  
LS PARTS ARE 7M SERIES  
LS AND 2M'S ARE LS

ES:

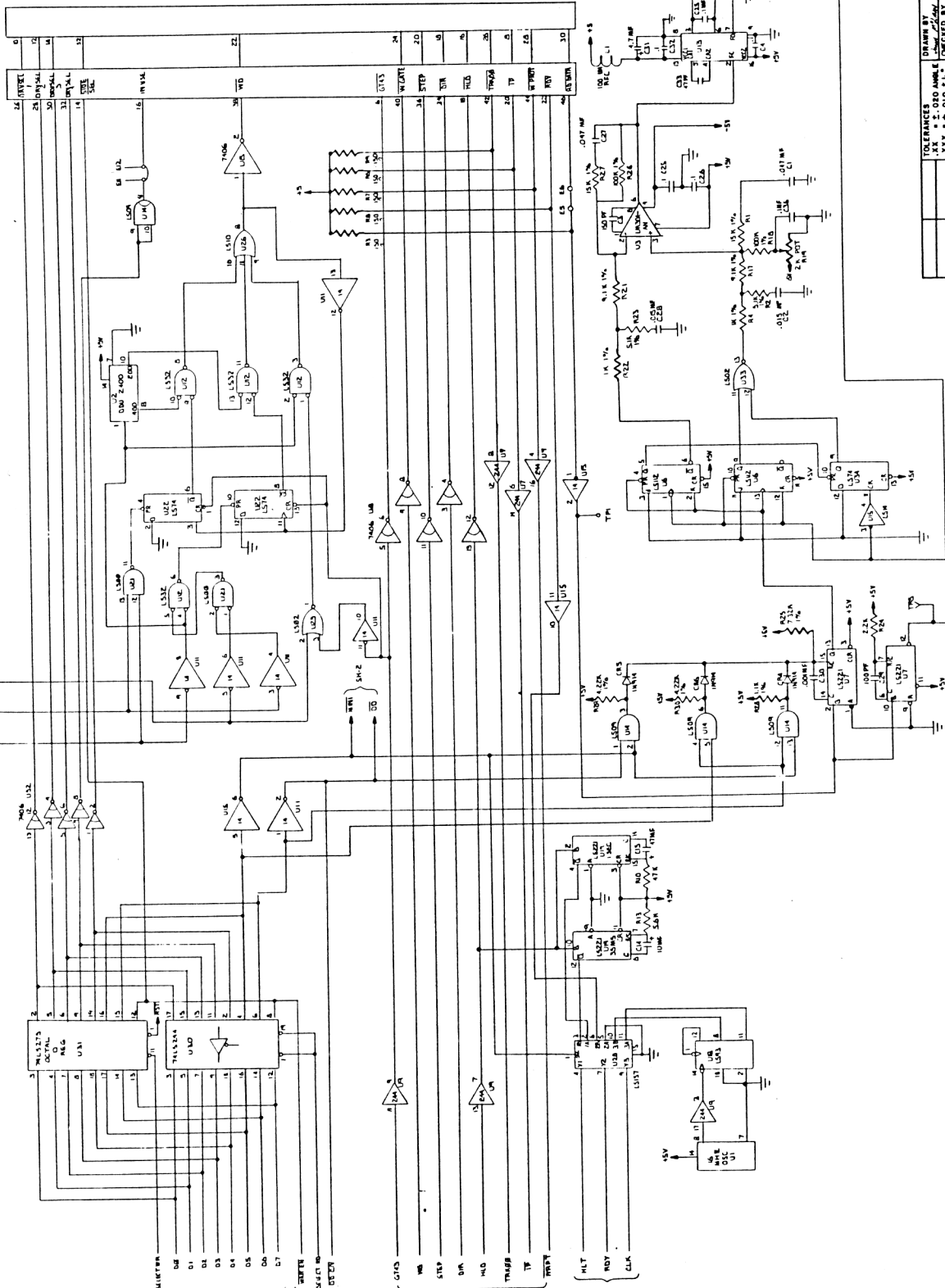

REF DES	LAST USED	UNUSED
C	C-3A	
A	R-33	R-40
J	U-3	U-4
CR	CR-7	
L	L-1	
VR	VR-1	
E	E-12	E-12.3
TP	TP-5	TP-4

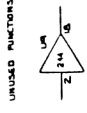

**SD SYSTEMS**  
BALDWIN, ILLINOIS

**YERKS FLOPPY II** SCHEMATIC

DATE: 11-2-71  
DRAWN BY: J. J. AMLE  
CHECKED BY: J. J. AMLE  
DESIGN ERROR: NONE  
MATERIAL: NONE  
FINISH: NONE

SIZE CODE IDENT: 0100151  
DATE: 11-2-71  
APPROVED: J. J. AMLE

SCALE: 100 NOT SCALE DRAWING SHEET 2 OF 2

APPLICATION: FLOPPY II

NOTES:

Head Alignment - Track 0 - Drive Drives

For Alignment

1. Test points - 1A + 1B on PCB Board (conv dir)
2. Jumper - Test Point 3 - Jumper on HA for HL
3. Loosen two screws holding down stepper motor,  
Turn motor back or forth for optimum alignment,  
Re-tighten screws.

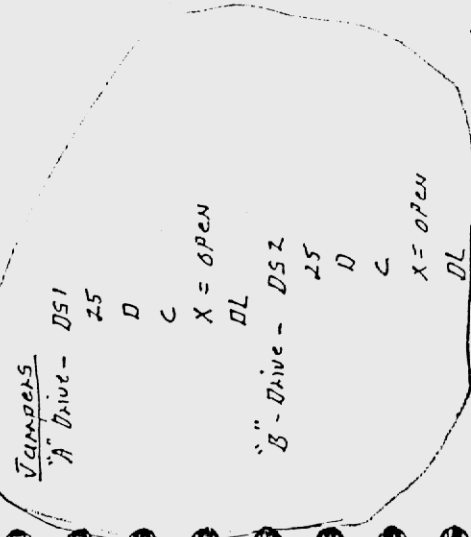

HA - For Head Load Align - only

Pin #9 out on Bottom Terminator

"B" drive only

Jumper from input pin #6 to L-1 on Both drives.

**1795 COMPATIBILITY WITH DDBIOS**

SD Systems is presently delivering Revision F Versafloppy II boards equipped with the 1795 Western Digital controller chip to the field. Earlier boards included the 1791 Western Digital controller chips. DDBIOS versions 3.0 and later operate with either the 1791 or 1795. However, earlier versions of DDBIOS only operate with the 1791 controller chip.

**To Identify Condition**

Check Versafloppy II boards when swapping boards within your system. The Versafloppy II board equipped with the 1795 Western Digital controller chip will only operate with DDBIOS version 3.0 and beyond.

Early versions of DDBIOS (2.0 - 2.3) that ran with the 1791 Western Digital controller chip will not operate with the 1795 Western Digital chip.

**To Resolve Condition**

Use only DDBIOS version 3.0 or beyond in combination with Rev. F Versafloppy II boards equipped with the 1795 Western Digital Controller Chips.



# SD Systems

P.O. Box 28810 • Dallas, Texas 75228 214-271-4887

## BILL OF MATERIALS

Title: VERSAFLOPPY II      PL No. 0100150      Rev. N  
 Date Released: \_\_\_\_\_      Approved: \_\_\_\_\_      Sheet 4 of 4

Item No.	QTY	SD-P/N	Description	Unit Cost	Extension
73	1	7030041	4.7 MF 25V CAPACITOR C31		
74	1	7030042	150 PF CAPACITOR C3		

# SD Systems

P.O. Box 28810 • Dallas, Texas 75228 214-271-4887

## BILL OF MATERIALS

Title: VERSAFLOPPY II      PL No. 0100150      Rev. N  
 Date Released: \_\_\_\_\_      Approved: \_\_\_\_\_      Sheet 1 of 4

Item No.	QTY	SD-P/N	Description	Unit Cost	Extension
1	1	7000013	VERSAFLOPPY II PCB # 0100152		
2	18	7060002	14 PIN IC SOCKET U4,8,11,12,14, THRU 18, 21 22, 24 THRU 26, 32, 33, 23, 34		
3	6	7060003	16 PIN IC SOCKET U5,6,7,13,19, 20		
4	6	7060005	20 PIN IC SOCKET U9,27 THRU 31		
5	1	7060009	40 PIN IC SOCKET U10		
6	2	7010007	7406 TTL IC U8 f U32		
7	1	7010160	74LS00 TTL IC U21		
8	2	7010162	74LS02 TTL IC U23 f U33		
9	2	7010168	74LS10 TTL IC U24 f U26		
10	3	7010172	74LS14 TTL IC U11, U15 f U17		
11	1	7010175	74LS21 TTL IC U16		
12	1	7010181	74LS32 TTL IC U12		
13	3	7010195	74LS74 TTL IC U22, U25 f U34		
14	2	7010205	74LS93 TTL IC U18 f U4		
15	1	7010225	74LS153 TTL IC U5		
16	1	7010228	74LS157 TTL IC U20		
17	3	7040001	IN914 DIODE CR4, CR5 f CR6		
18	2	7010259	74LS221 TTL IC U7 f U19		
19	2	7010260	74LS240 TTL IC U28 f U29		
20	3	7010264	74LS244 TTL IC U9, U27 f U30		
21	1	7010276	74LS273 TTL IC U31		
22	1	7080006	16 MHZ CRYSTAL U1		
23	1	7010371	DOJ 4-2400 DELAY LINE U2		
24	1	7060001	8 PIN IC SOCKET		

# SD Systems

P.O. Box 28810 • Dallas, Texas 75228 214-271-4667

## BILL OF MATERIALS

Title: **VERSAFLOPPY II** PL No. **0100150** Rev. **N**  
 Date Released: \_\_\_\_\_ Approved: \_\_\_\_\_ Sheet **2** Of **4**

Item No.	Qty	SD-P/N	Description	Unit Cost	Extension
25	1	7020051	120 OHM RESISTOR 5% 1/4 WATT R15		
26	5	7020053	150 OHM RESISTOR 5% 1/4 WATT R3,R6,R7,R8,R9		
27	2	7130072	PCB EJECTOR		
28					
29	1	7020091	5.6 K OHM RESISTOR 5% 1/4 WATT R13		
30	3	7020097	10K OHM RESISTOR 5% 1/4 WATT R5,R11,R12		
31	1	7020113	47K OHM RESISTOR 5% 1/4 WATT R10		
32	22	7030045	1MF CAPACITOR C4 TO C13, C16, C20 TO C26, C32,C35 TO C37		
33	5	7030009	10MF 25V CAPACITOR C14,C17,C18, C19,C34		
34	1	7030010	47 MF CAPACITOR C15		
35					
36					
37	1	7040004	IN4742 12V ZENER DIODE CRI		
38	1	7160001	LM340T-5 VOLTAGE REGULATOR VR1		
39	1	7130005	HEATSINK		
40	1	7130015	6-32 x 5/16 PPH SCREW		
41	1	7130007	6-32 HEX NUT		
42	4	7170001	WIRE WRAP PINS TP1,2,3,5		
43	1	7090043	CONNECTOR 34 PIN J2		
44	1	7090042	CONNECTOR 50 PIN J3		
45	4	7130078	FLOPPY CABLE EJECTOR CLIPS		
46	1	7010391	FD-1795B FLOPPY CONTROLLER U10		
47	2	7040011	DIODE CR2,R CR3, IN270		
48	2	7020081	2.2 K OHM RESISTOR 5% 1/4 WATT R16,R24		

# SD Systems

P.O. Box 28810 • Dallas, Texas 75228 214-271-4667

## BILL OF MATERIALS

Title: **VERSAFLOPPY II** PL No. **0100150** Rev. **N**  
 Date Released: \_\_\_\_\_ Approved: \_\_\_\_\_ Sheet **3** Of **4**

Item No.	Qty	SD-P/N	Description	Unit Cost	Extension
49	1	7010401	74S09 TTL IC U14		
50	1	7010210	74LS112 TTL IC U6		
51	1	7020200	2KΩ POT R19		
52	1	7010404	74LS629 TTL IC U13 (OR 74LS124)		
53	1	7160009	LM 301AN OPERATION U3		
54	2	7020193	4.22 K 1% 1/4 WATT RESISTOR R29,R30		
55	1	7020192	1.1K 1% 1/4 WATT RESISTOR R28		
56	1	7020195	7.32K 1% 1/4 WATT RESISTOR R25		
57	2	7020191	1K 1% 1/4 WATT RESISTOR R4,R22		
58	2	7020194	5.11K 1% 1/4 WATT RESISTOR R2,R23		
59	2	7020196	9.094K 1% 1/4 WATT RESISTOR R17,R21		
60	2	7020197	15K 1% 1/4 WATT RESISTOR R1,R27		
61	2	7020198	100K 1% 1/4 WATT RESISTOR R18,R26		
62	1	7020189	200Ω 1% 1/4 WATT RESISTOR R31		
63	1	7020190	301Ω 1% 1/4 WATT RESISTOR R32		
64					
65	1	7020069	680Ω 5% 1/4 WATT RESISTOR R33		
66	1	7120002	100 UH RF CHOKE WEE-WEE-100 L1		
67	1	7040003	IN751A 5.1 ZENER DIODE CR7		
68	1	7030035	.001 MF CAPACITOR C30		
69	1	7030004	100 PF CAPACITOR C29		
70	2	7030037	.015 MF CAPACITOR C2,C28		
71	2	7030038	.047 MF CAPACITOR C1,C27		
72	1	7030004	100 PF CAPACITOR C33		

REVISIONS		
LTR	DESCRIPTION	DATE APP
K	PER E.C.N. 130	1/10/74
L	PER E.C.N. 131	1/10/74
M	PER E.C.N. 152/174	1/10/74

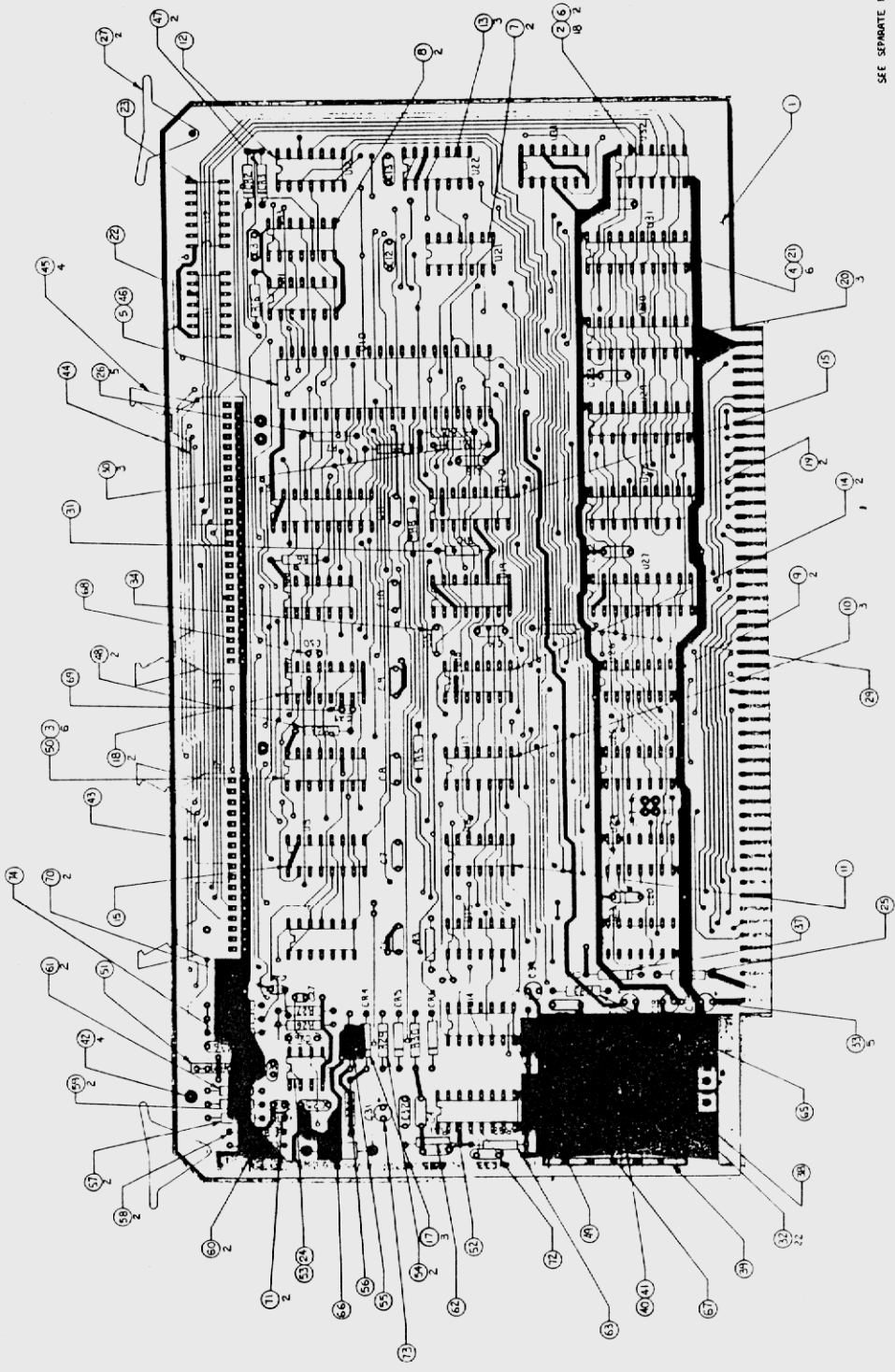

SEE SEPARATE BLOW 0000150

TOLERANCES		DRAWN BY		DATE	
XX	±0.00 ANGLE				
XXX	±0.00				
XXXX	±0.00				
XXXXX	±0.00				
MATERIAL		DESIGNED BY		DATE	
		DESIGN ENGR		DATE	
		APPROVED		DATE	
FINISH		DRAWING NO.		REV	
		0100150		D	
MATERIAL USED ON		SCALE		SHEET 1 OF 5	
APPLICATION		SD SYSTEMS		VERSIFLOPPY II	
		SARLINO, J. J.		ASSY DRAWING	

NOTES:

### SD-100 AND SD-200

SD-100 and SD-200 systems are originally shipped with a pair of Mod 4 MFE or Mod 5 MFE drives. Field usage has determined that system problems can occur when a Mod 4 MFE drive is mixed with a Mod 5 MFE drive. This is a potential problem only if a system has required a MFE drive replacement and that MFE drive Mod replacement does not match the original. If a SD-100/200 contains mixed drives due to drive replacement, log on failures can occur.

**TO IDENTIFY PROBLEM:**

Check the MFE drives for uniformity.

Mod 4 chassis is smooth, obviously machine casted and has no seam.

Mod 5 chassis is a darker cast and has a seam edge.

**TO MODIFY SYSTEM:**

(1.) Cut straps PS6 and LC2 on Mod 5 drives, as this solves the problem which can occur due to an option strap on this drive between PS2 and PS6 near J1. Note diagram below.

(2.) If assistance is required, call our Technical Assistance hot line number: 1-800-527-4121.

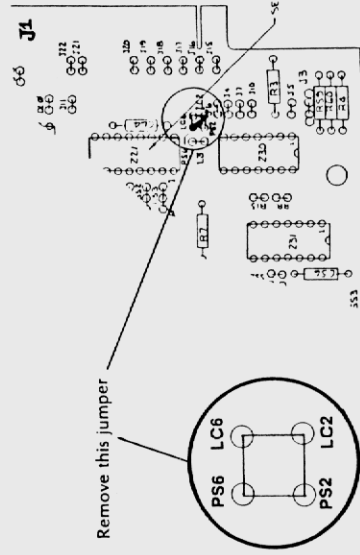

### VERSAFLOPPY II

SD Systems was notified by Western Digital that a mask modification was made to the 1795 controller chip to improve performance and error recovery capability. In our continuing effort to provide and maintain products of the highest quality, we strongly recommend that anyone having 1795 chips with the 801 designation call our customer service department and arrange for immediate replacement with a 1795 chip having the 802 designation.

The information contained herein is intended to be a general advisory only and is subject to change without product involvement.

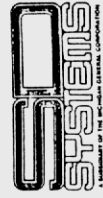



OPTIONS JUMPERS FOR 8" DRIVES:

QUME

- C
- D
- DL
- DS1 For A drive
- DS2 For B drive
- 2S

Cut X  
Add jumper from pin 6 of J1 to L1

MFE

- DL-2
- DS-1 For A drive
- DS-2 For B drive
- HL-1
- HL-2
- HL-4
- HS-1
- J-12
- L-1
- RHL
- SE-2

SHUGART 8 in.

- A
- B
- C
- HL
- T1
- T2
- T3 - T6 on B drive only
- 800
- Y
- DS1 For A drive
- DS2 For B drive

SHUGART 5 1/2 in.

- HM
- DS-1 For A drive
- DS-2 For B drive
- E-1 Terminator pack for last drive

MEMO

TO: Fred Friedrichs  
FROM: Dan Hammond  
DATE: January 31, 1980  
SUBJECT: JUMPERS ON SHUGART DRIVES

The following is a complete list of jumpers for the Shugart SA800R drives used in the SD-100A.

- A
- B
- C
- HL
- T3-T6 (Drive B only)
- T1
- T2
- 800
- Y (Drive A only)
- DS1 (Drive B only)
- DS2 (Drive B only)
- ~~DS3~~ (Drive A only)
- X for AT, last only.

*[Signature]*  
(Signature)

DDH:kyh

cc: Robert Montoya

To OPEN  
P63 Return  
FF Return

WHITE  
MFE  
6-F-600  
1. 550 = 0  
2. 551 = 1  
00-Track sect  
01- " "

Test Points for A1

Trigger Pin #12

A- #1  
B- #2

WHITE  
1. 6-F-600  
2. 5500 C.D. Sing Side  
Read  
Z11

press - stop

MATERIAL		DATE		REV	
DESCRIPTION		DATE		REV	
DRAWING NO.		DATE		REV	
DRAWING TITLE		DATE		REV	
DRAWING NO.		DATE		REV	
DRAWING TITLE		DATE		REV	
DRAWING NO.		DATE		REV	
DRAWING TITLE		DATE		REV	
DRAWING NO.		DATE		REV	
DRAWING TITLE		DATE		REV	

NOTE: 1. D-D/D-D DENOTES CUT TRACE/JUMPER OPTION.  
2. O DENOTES TEST POINTS.

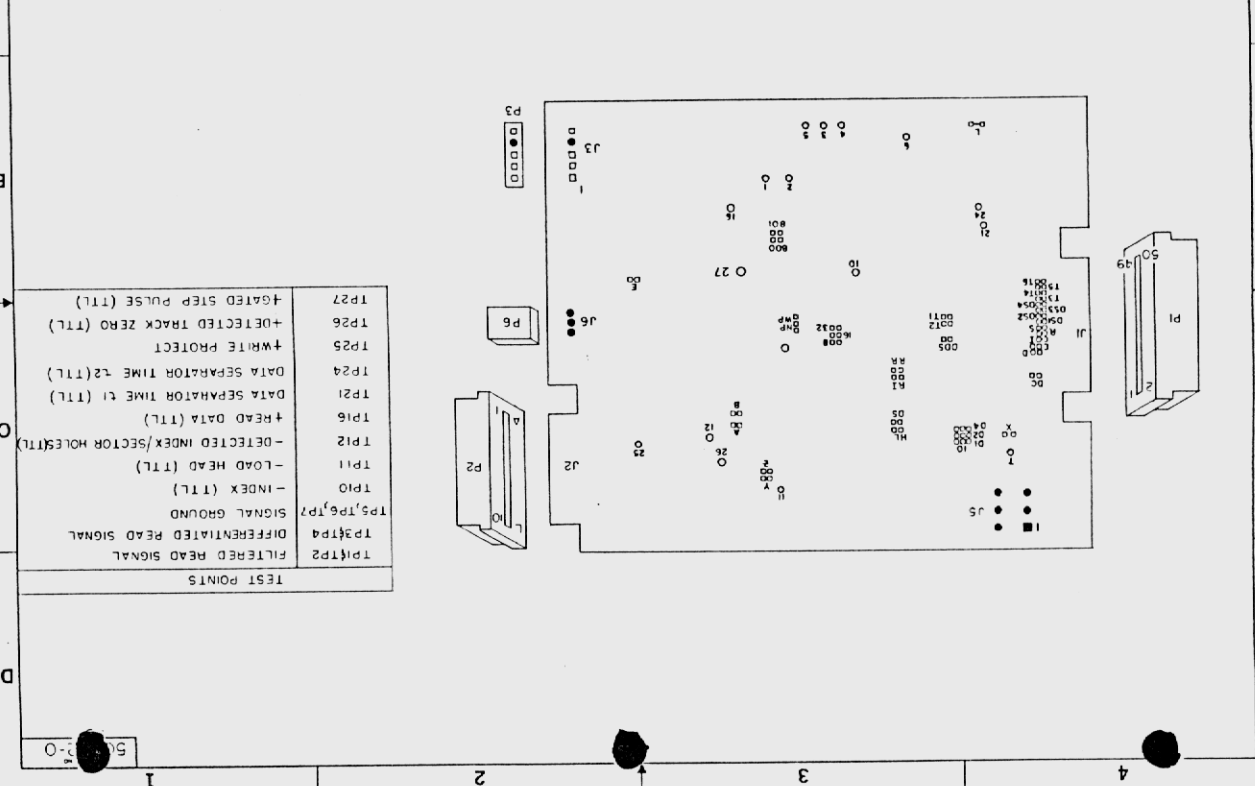

TEST POINTS

TP1P2	FILTERED READ SIGNAL
TP3P4	DIFFERENTIATED READ SIGNAL
TP5,TP6,TP7	SIGNAL GROUND
TP10	-INDEX (TTL)
TP11	-LOAD HEAD (TTL)
TP12	-DETECTED INDEX/SECTOR HOLE(TTL)
TP16	+READ DATA (TTL)
TP21	DATA SEPARATOR TIME t1 (TTL)
TP24	DATA SEPARATOR TIME t2 (TTL)
TP25	+WRITE PROTECT
TP26	+DETECTED TRACK ZERO (TTL)
TP27	+GATED STEP PULSE (TTL)

INDEX

PCB TRACE "BOO" TRACE "BOO" TRACE "BOO"

FACTORY CUT TRACE OPTIONS

25107	OPEN	SHORTED	OPEN
25106	SHORTED	SHORTED	OPEN
25105	OPEN	OPEN	SHORTED
25104	SHORTED	SHORTED	OPEN
25103	OPEN	OPEN	SHORTED
25102	SHORTED	OPEN	SHORTED

TABLE II FACTORY CUT TRACE OPTIONS

WRITE PROTECT CAN BE ORDERED WITH ANY OF THE ABOVE

PCB ASM NO.	-7 TO DATA SECTOR	-5V	-15V	-7 TO DATA SECTOR
25102	X			
25103		X		
25104			X	
25105		X	X	
25106			X	X
25107	X	X	X	X

TABLE I OPTIONAL FEATURES

LOGIC MANUAL P/N 50590 - I

INDEX

PCB TRACE AND TEST POINT LOCATIONS

READ/WRITE/INDEX/SECTOR

STEPPER CONTROL

DETECTORS

MOTORS SOLENOID SWITCH

TABLE III CUSTOMER CUT TRACE OPTIONS

DESIGNATOR	DESCRIPTION	SHIPPED FROM FACTORY	OPEN	SHORT
13,14,15 & 16	TERMINATIONS FOR MULTIPLEXED INPUTS	X		
17	SPARE TERMINATOR FOR RADIAL HEAD LOAD	X		
18	TERMINATION FOR DRIVE SELECT	X		
19	DRIVE SELECT INPUT - ALTERNATE PINS:02,03,05,04	X		
20	RADIAL READ	X		
21	RADIAL INDEX AND SECTOR	X		
22	HEAD,INDEX,SECTOR ALTERNATE OUTPUT PROVISION	X		
23	RADIAL HEAD LOAD	X		
24	STEPPER POWER FROM HD LD	X		
25	STEPPER POWER FROM DRIVE SELECT	X		
26	INHIBIT WHITE WHEN WHITE PROTECTED	X		
27	ALLOW WHITE WHEN WHITE PROTECTED	X		
28	B16 OR 32 SECTORS	X		
29	ALTERNATE INPUT - IN USE	X		
30	NINE ALTERNATE I/O PINS	X		
31	CUSTOMER INSTALLABLE DECODE DRIVE SELECT OPTION	X		
32	ALTERNATE INPUT - HEAD LOAD	X		
33	INUSE LED FROM DRIVE SELECT	X		
34	INUSE LED FROM HD LD	X		
35	ALTERNATE OUTPUT-DISK CHANGE	X		

FACTORY CUT TRACE OPTIONS AND HISTORY CHART

L 5 OR -7 TO -16V SEE TABLE D

BOO INDEX ONLY (BOO) SEE TABLE D

BOI INDEX AND SECTOR(BOI) SEE TABLE D

DC

ALTERNATE INPUT - DISK CHANGE

INUSE LED FROM HD LD

INUSE LED FROM DRIVE SELECT

ALTERNATE INPUT - HEAD LOAD

CUSTOMER INSTALLABLE DECODE DRIVE SELECT OPTION

NINE ALTERNATE I/O PINS

ALTERNATE INPUT - IN USE

B16 OR 32 SECTORS

ALLOW WHITE WHEN WHITE PROTECTED

INHIBIT WHITE WHEN WHITE PROTECTED

STEPPER POWER FROM DRIVE SELECT

STEPPER POWER FROM HD LD

RADIAL HEAD LOAD

RADIAL INDEX AND SECTOR

HEAD,INDEX,SECTOR ALTERNATE OUTPUT PROVISION

RADIAL HEAD LOAD

STEPPER POWER FROM DRIVE SELECT

ALLOW WHITE WHEN WHITE PROTECTED

INHIBIT WHITE WHEN WHITE PROTECTED

B16 OR 32 SECTORS

ALTERNATE INPUT - IN USE

NINE ALTERNATE I/O PINS

CUSTOMER INSTALLABLE DECODE DRIVE SELECT OPTION

ALTERNATE INPUT - HEAD LOAD

INUSE LED FROM DRIVE SELECT

INUSE LED FROM HD LD

ALTERNATE OUTPUT-DISK CHANGE

DC

FACTORY CUT TRACE OPTIONS AND HISTORY CHART

L 5 OR -7 TO -16V SEE TABLE D

BOO INDEX ONLY (BOO) SEE TABLE D

BOI INDEX AND SECTOR(BOI) SEE TABLE D

DC

ALTERNATE INPUT - DISK CHANGE

INUSE LED FROM HD LD

INUSE LED FROM DRIVE SELECT

ALTERNATE INPUT - HEAD LOAD

CUSTOMER INSTALLABLE DECODE DRIVE SELECT OPTION

NINE ALTERNATE I/O PINS

ALTERNATE INPUT - IN USE

B16 OR 32 SECTORS

ALLOW WHITE WHEN WHITE PROTECTED

INHIBIT WHITE WHEN WHITE PROTECTED

STEPPER POWER FROM DRIVE SELECT

STEPPER POWER FROM HD LD

RADIAL HEAD LOAD

RADIAL INDEX AND SECTOR

HEAD,INDEX,SECTOR ALTERNATE OUTPUT PROVISION

RADIAL HEAD LOAD

STEPPER POWER FROM DRIVE SELECT

ALLOW WHITE WHEN WHITE PROTECTED

INHIBIT WHITE WHEN WHITE PROTECTED

B16 OR 32 SECTORS

ALTERNATE INPUT - IN USE

NINE ALTERNATE I/O PINS

CUSTOMER INSTALLABLE DECODE DRIVE SELECT OPTION

ALTERNATE INPUT - HEAD LOAD

INUSE LED FROM DRIVE SELECT

INUSE LED FROM HD LD

ALTERNATE OUTPUT-DISK CHANGE

DC

FACTORY CUT TRACE OPTIONS AND HISTORY CHART

L 5 OR -7 TO -16V SEE TABLE D

BOO INDEX ONLY (BOO) SEE TABLE D

BOI INDEX AND SECTOR(BOI) SEE TABLE D

DC

ALTERNATE INPUT - DISK CHANGE

INUSE LED FROM HD LD

INUSE LED FROM DRIVE SELECT

ALTERNATE INPUT - HEAD LOAD

CUSTOMER INSTALLABLE DECODE DRIVE SELECT OPTION

NINE ALTERNATE I/O PINS

ALTERNATE INPUT - IN USE

B16 OR 32 SECTORS

ALLOW WHITE WHEN WHITE PROTECTED

INHIBIT WHITE WHEN WHITE PROTECTED

STEPPER POWER FROM DRIVE SELECT

STEPPER POWER FROM HD LD

RADIAL HEAD LOAD

RADIAL INDEX AND SECTOR

HEAD,INDEX,SECTOR ALTERNATE OUTPUT PROVISION

RADIAL HEAD LOAD

STEPPER POWER FROM DRIVE SELECT

ALLOW WHITE WHEN WHITE PROTECTED

INHIBIT WHITE WHEN WHITE PROTECTED

B16 OR 32 SECTORS

ALTERNATE INPUT - IN USE

NINE ALTERNATE I/O PINS

CUSTOMER INSTALLABLE DECODE DRIVE SELECT OPTION

ALTERNATE INPUT - HEAD LOAD

INUSE LED FROM DRIVE SELECT

INUSE LED FROM HD LD

ALTERNATE OUTPUT-DISK CHANGE

DC

FACTORY CUT TRACE OPTIONS AND HISTORY CHART

L 5 OR -7 TO -16V SEE TABLE D

BOO INDEX ONLY (BOO) SEE TABLE D

BOI INDEX AND SECTOR(BOI) SEE TABLE D

DC

ALTERNATE INPUT - DISK CHANGE

INUSE LED FROM HD LD

INUSE LED FROM DRIVE SELECT

ALTERNATE INPUT - HEAD LOAD

CUSTOMER INSTALLABLE DECODE DRIVE SELECT OPTION

NINE ALTERNATE I/O PINS

ALTERNATE INPUT - IN USE

B16 OR 32 SECTORS

ALLOW WHITE WHEN WHITE PROTECTED

INHIBIT WHITE WHEN WHITE PROTECTED

STEPPER POWER FROM DRIVE SELECT

STEPPER POWER FROM HD LD

RADIAL HEAD LOAD

RADIAL INDEX AND SECTOR

HEAD,INDEX,SECTOR ALTERNATE OUTPUT PROVISION

RADIAL HEAD LOAD

STEPPER POWER FROM DRIVE SELECT

ALLOW WHITE WHEN WHITE PROTECTED

INHIBIT WHITE WHEN WHITE PROTECTED

B16 OR 32 SECTORS

ALTERNATE INPUT - IN USE

NINE ALTERNATE I/O PINS

CUSTOMER INSTALLABLE DECODE DRIVE SELECT OPTION

ALTERNATE INPUT - HEAD LOAD

INUSE LED FROM DRIVE SELECT

INUSE LED FROM HD LD

ALTERNATE OUTPUT-DISK CHANGE

DC

FACTORY CUT TRACE OPTIONS AND HISTORY CHART

L 5 OR -7 TO -16V SEE TABLE D

BOO INDEX ONLY (BOO) SEE TABLE D

BOI INDEX AND SECTOR(BOI) SEE TABLE D

DC

ALTERNATE INPUT - DISK CHANGE

INUSE LED FROM HD LD

INUSE LED FROM DRIVE SELECT

ALTERNATE INPUT - HEAD LOAD

CUSTOMER INSTALLABLE DECODE DRIVE SELECT OPTION

NINE ALTERNATE I/O PINS

ALTERNATE INPUT - IN USE

B16 OR 32 SECTORS

ALLOW WHITE WHEN WHITE PROTECTED

INHIBIT WHITE WHEN WHITE PROTECTED

STEPPER POWER FROM DRIVE SELECT

STEPPER POWER FROM HD LD

RADIAL HEAD LOAD

RADIAL INDEX AND SECTOR

HEAD,INDEX,SECTOR ALTERNATE OUTPUT PROVISION

RADIAL HEAD LOAD

STEPPER POWER FROM DRIVE SELECT

ALLOW WHITE WHEN WHITE PROTECTED

INHIBIT WHITE WHEN WHITE PROTECTED

B16 OR 32 SECTORS

ALTERNATE INPUT - IN USE

NINE ALTERNATE I/O PINS

CUSTOMER INSTALLABLE DECODE DRIVE SELECT OPTION

ALTERNATE INPUT - HEAD LOAD

INUSE LED FROM DRIVE SELECT

INUSE LED FROM HD LD

ALTERNATE OUTPUT-DISK CHANGE

DC

FACTORY CUT TRACE OPTIONS AND HISTORY CHART

L 5 OR -7 TO -16V SEE TABLE D

BOO INDEX ONLY (BOO) SEE TABLE D

BOI INDEX AND SECTOR(BOI) SEE TABLE D

DC

ALTERNATE INPUT - DISK CHANGE

INUSE LED FROM HD LD

INUSE LED FROM DRIVE SELECT

ALTERNATE INPUT - HEAD LOAD

CUSTOMER INSTALLABLE DECODE DRIVE SELECT OPTION

NINE ALTERNATE I/O PINS

ALTERNATE INPUT - IN USE

B16 OR 32 SECTORS

ALLOW WHITE WHEN WHITE PROTECTED

INHIBIT WHITE WHEN WHITE PROTECTED

STEPPER POWER FROM DRIVE SELECT

STEPPER POWER FROM HD LD

RADIAL HEAD LOAD

RADIAL INDEX AND SECTOR

HEAD,INDEX,SECTOR ALTERNATE OUTPUT PROVISION

RADIAL HEAD LOAD

STEPPER POWER FROM DRIVE SELECT

ALLOW WHITE WHEN WHITE PROTECTED

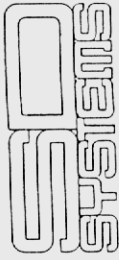

January 15, 1980

VERSAFLOPPY II

ADDENDUM VERSAFLOPPY II  
OPERATIONS MANUAL

FIRMAPE: INSTALLED ON THE SBC 100/200

FOR REV. F BOARDS

- 39034 DBBIOS V3.1 - FOR USE WITH MFE DRIVES
- 39034 DBBIOS V3.1Q - FOR USE WITH QUME DRIVES
- 39106 DBBIOS V3.2S - FOR USE WITH SHUGART DRIVES
- 39034 DBBIOS V3.2Q - FOR OASIS OPERATING SYSTEM

- \* VF II WITH 1791 CONTROLLER CHIP WILL ONLY WORK WITH DBBIOS V2.3 OR EARLIER VERSIONS.
- \* VF II WITH 1795 CONTROLLER CHIP WILL ONLY WORK WITH DBBIOS V3.0 OR LATER.
- \* VF II WITH 1795 CHIPS SHOULD BE B-02 TYPE.

JUMPERS: FACTORY SET AND CHANGEABLE WITHOUT ETCH CUTS E8 TO E9 - CONNECTS DRQ TO VI3.

(needed for COSMOS & SDOS 1.8B)

PORTS:

- 60 (0) - RESET CONTROLLER
  - 63 (I) - READS STATUS OF OUTPUT PORT 63
  - 63 (0) - BIT
- |   |   |                                    |                            |
|---|---|------------------------------------|----------------------------|
| 0 | } | DRIVE SELECT                       |                            |
| 1 |   |                                    |                            |
| 2 |   |                                    |                            |
| 3 | } | SIDE SELECT 0 = SIDE 0, 1 = SIDE 1 |                            |
| 4 |   |                                    |                            |
| 5 |   |                                    | 5 1/8" 0 = 8", 1 = 5 1/8"  |
| 6 |   |                                    | DENSITY 0 = S.D., 1 = D.D. |
| 7 |   | WAIT ENABLE                        |                            |
- 64 (0) - COMMAND
  - 64 (I) - STATUS
  - 65 (0) - TRACK
  - 66 (0) - SECTOR
  - 67 (0) - DATA WRITE
  - 67 (I) - DATA READ

The following changes must be noted when assembling the Versafloppy II kit.

- 1) R 12 is a 100 K OHM resistor.
- 2) You must add a 330 pf. cap to GND from pin 38 end of R12.
- 3) You must add a 47K OHM resistor to ground from pin 1 of U10.

Note: If the board in your kit is REV. C (see the silk screen on the board) the following changes must also be made.

- 4) Cut the etch between pins 3 and 4 of ICU3.
- 5) Add jumpers between pins 16, 5, 7 and 10.

The 1791B-1 controller chip is not capable of reading formats with zeroes only in the gaps. Therefore, until the 1795B-1 becomes available, disks previously formatted with all zero gaps must be converted to the 3740 format with 0's and 1's in the gaps. This can be accomplished by formatting a new diskette with the VF II board. Then insert this diskette in the system where the diskette was created and transfer the desired data to the new diskette.